

Orthopaedic

Bone Cutting Forceps	140
Bone Rongeurs	141
Bone Holding Forceps	144
Bone Holding Clamps	146
Plaster Spreaders and Shears	147
Bone Curettes	148
Bone Levers	153
Retractors	154
Dissecting Forceps and Hooks	156
Raspatories, Burr and Rugines	157
Osteotomes, Chisels and Gouges	158
Wire Cutters and Pliers	161
Accessories	164
Mallets	165
Raspatories, Files and Punches	167
Pushers, Impactors and Skids	168
Elevators	169
Retractors and Bone Levers	172
Saws, Shears and Knives	173
Screw and Plate Instruments	173
Pins	174
Sterile Kirschner and Arthrodesis Wires	175
Extremities Instruments and Sets	176
Shoulder Instruments	178



Bone Cutting Forceps

McIndoe Bone Cutting Forcep

Lightweight, compound action, angled jaw with prismatic points

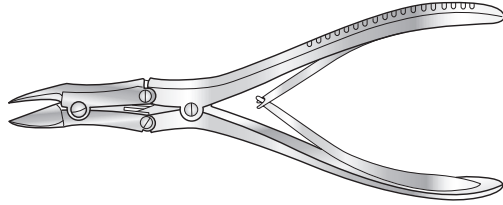

Code	Description
SC-OR/13b	165mm long
SC-OR/13c	191mm long

Liston Box Joint Bone Cutting Forcep

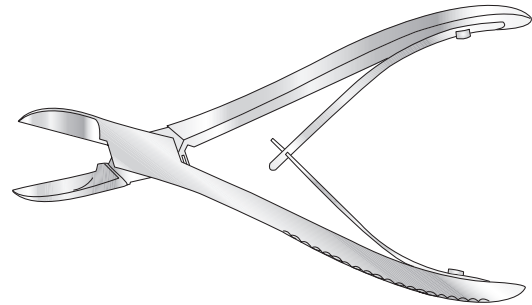

Straight

Code	Description
SC-OR/032	140mm long
SC-OR/033	200mm long
SC-OR/027	220mm long

Angled

Code	Description
SC-OR/061	170mm long
SC-OR/062	220mm long

Liston Screw Joint Bone Cutting Forcep

With fluted handle

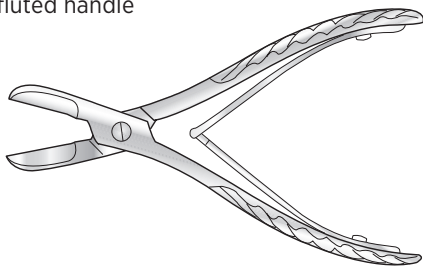

150mm long

Code	Description
SC-OR/24	Straight
SC-OR/24a	Angled

200mm long

Code	Description
SC-OR/26	Straight

180mm long

Code	Description
SC-OR/25	Straight
SC-OR/25a	Angled

230mm long

Code	Description
SC-OR/27	Straight

Screw Joint Bone Cutting Forcep

Straight

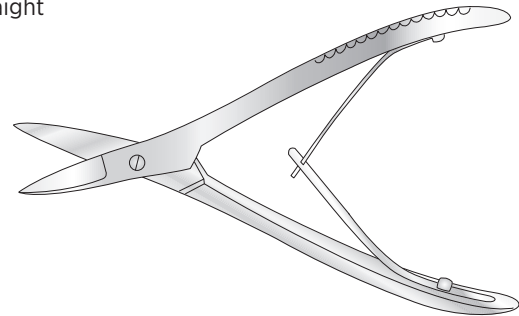

Code	Description
SC-OR/030	160mm long

Liston Compound Action Bone Cutting Forcep

Straight, for heavy duty

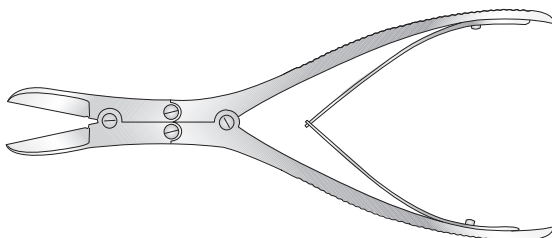

Code	Description
SC-OR/27a	305mm long
SC-OR/27b	300mm long
SC-OR/27c	190mm long

Ruskin-Liston Bone Cutting Forcep

Compound action, fine

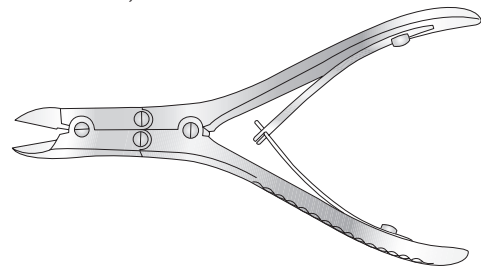

Straight

Code	Description
SC-OR/057	140mm long
SC-OR/074	145mm long
SC-OR/073	190mm long

Angled

Code	Description
SC-OR/063	190mm long

Ward Bone Cutting Forceps

Slightly angled on flat

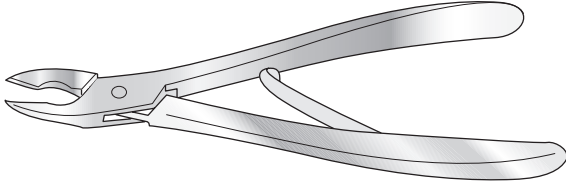

Code	Description
SC-GI/459	180mm long

Kleinert Kutz Bone Rongeur

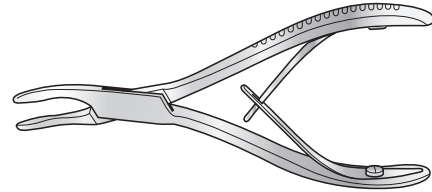

Code	Description
SC-OR/009a	Curved, 140mm, width 2mm
SC-OR/009	Curved, 155mm, width 2mm
SC-OR/011	Curved, 155mm, width 3mm

Horsley Compound Action Bone Cutter

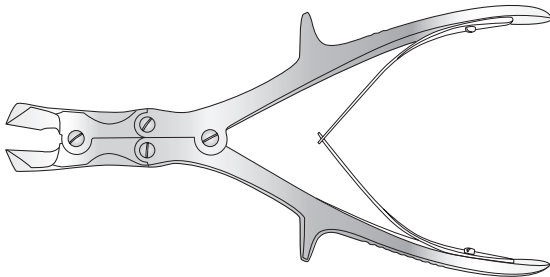

Code	Description
SC-OR/002	235mm long

Kleinert Kutz Skin Hooks



Code	Description
SC-PL/109	16cm large
SC-PL/108	16cm medium
SC-PL/107	16cm small

Stamms Box Joint Bone Cutter

Standard, stainless steel

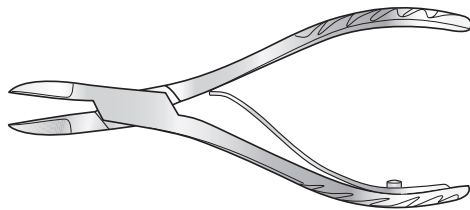

Code	Description
SC-OR/N056	140mm long

Bone Rongeurs

Echlin Compound Action Bone Rongeur

Straight, with or without horn, 230mm long

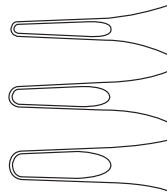
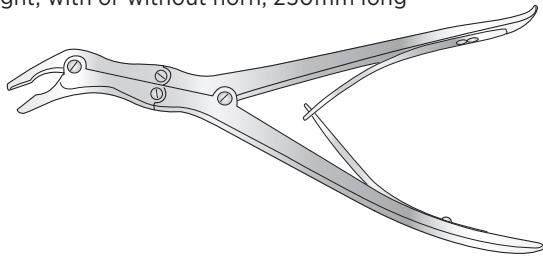

Code	Description
SC-OR/005	Width 2mm
SC-OR/006	Width 3mm
SC-OR/007	Width 4mm

Stille Compound Action Bone Rongeur

Angled to side, 240mm long

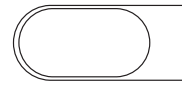
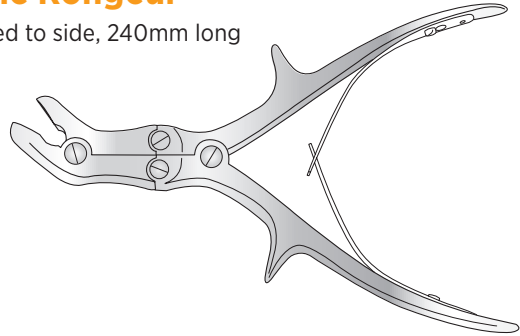

Code	Description
SC-OR/037	11mm bite

Leksell Compound Action Bone Rongeur

250mm long

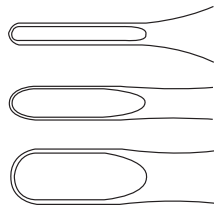
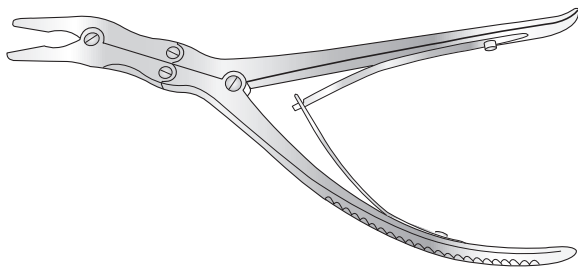

Code	Description
SC-OR/066	3mm bite
SC-OR/069	5mm bite
SC-OR/065	8mm bite

Leksell Stille Compound Action Bone Rongeur

240mm long

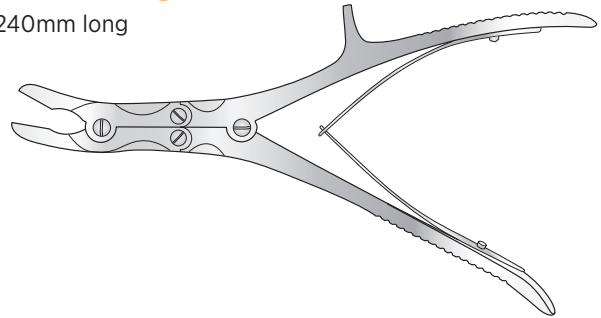

Code	Description
SC-OR/065a	8mm bite

Leksell Compound Action Bone Rongeur

240mm long

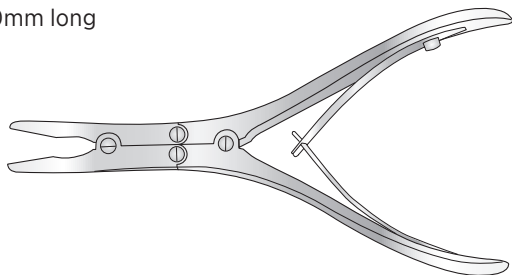

Code	Description
SC-OR/008	Width 3mm

Luer Stille Compound Action Bone Rongeur

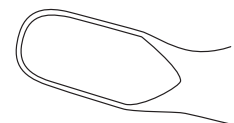
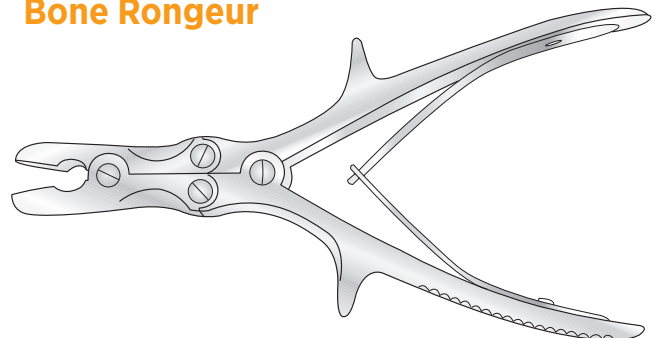

Straight

Code	Description
SC-OR/071	10mm bite, 220mm long
SC-OR/072	12mm bite, 260mm long

Curved

Code	Description
SC-OR/071a	10mm bite, 220mm long
SC-OR/071b	11mm bite, 230mm long

Luer Compound Action Bone Rongeur

6mm bite, 190mm long

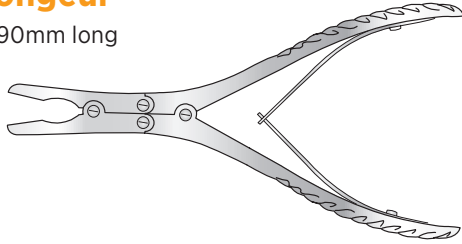

Code	Description
SC-OR/13	Straight
SC-OR/13a	Curved

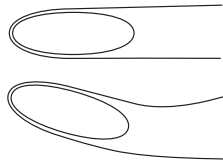

Ruskin Compound Action Bone Rongeur

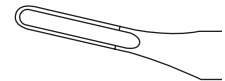
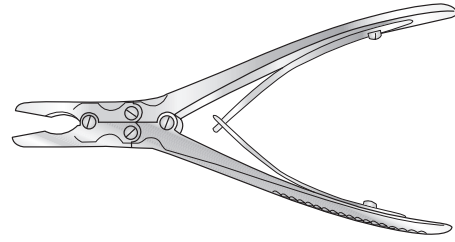

3mm bite, 150mm long

Code	Description
SC-OR/034	Straight
SC-OR/035	Curved

4mm bite, 185mm long

Code	Description
SC-OR/028	Straight
SC-OR/036	Curved

Luer Box Joint Bone Rongeur

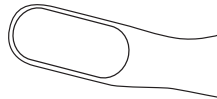
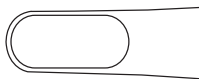
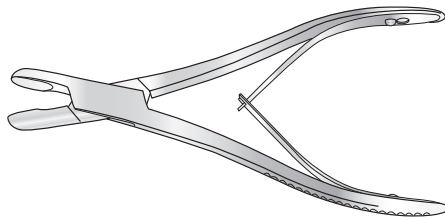

Straight, 185mm long

Code	Description
SC-OR/031	8mm bite
SC-OR/041	10mm bite

Curved, 210mm long

Code	Description
SC-OR/042	8mm bite

Compound Action Bone Rongeur

Lightweight pattern, curved, 150mm long

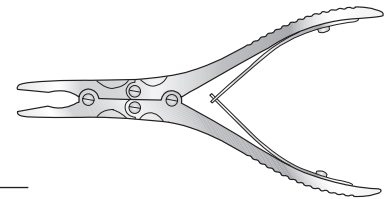

Code	Description
SC-OR/013d	4mm bite

Cushing Screw Joint Bone Rongeur

190mm long

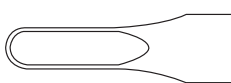
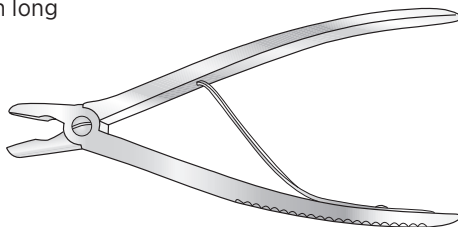

Straight

Code	Description
SC-OR/039	4mm bite
SC-OR/058	6mm bite
SC-OR/059	8mm bite

Curved

Code	Description
SC-OR/060	4mm bite
SC-OR/067	6mm bite
SC-OR/068	8mm bite

Lempert Box Joint Bone Rongeur

3mm bite, 155mm long

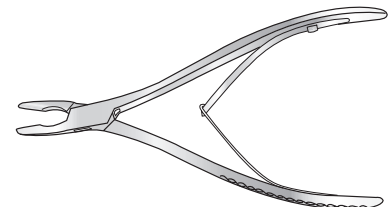

Code	Description
SC-OR/327	Straight
SC-OR/010	Curved

Bone Holding Forceps

Lambotte Bone Holding Forceps

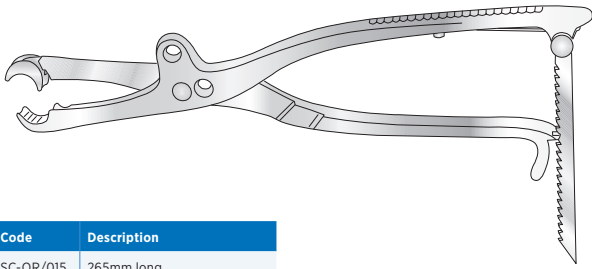

Code	Description
SC-OR/015	265mm long

Bone Holding Forceps

Screw joint, with holding screw

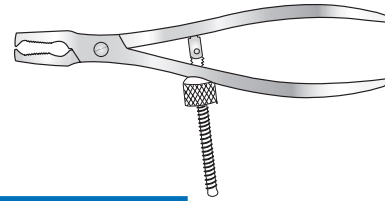

Code	Description
SC-OR/029	165mm long

Lambotte Bone Holding Forceps

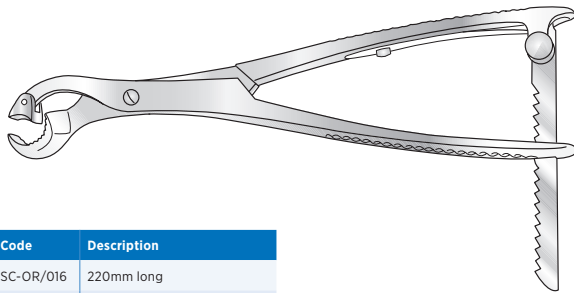

Code	Description
SC-OR/016	220mm long
SC-OR/017	215mm long
SC-OR/022	330mm long

Hey Groves Bone Holding Forceps

With screw locking device



Code	Description
SC-OR/29d	200mm long
SC-OR/29e	225mm long
SC-OR/29f	305mm long

Farabeuf Bone Holding Forceps

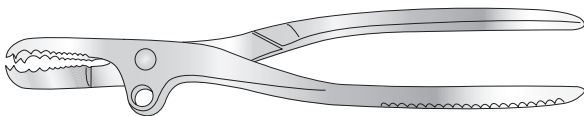

Code	Description
SC-OR/021	230mm long
SC-OR/328	250mm long

Bone Holding Forceps

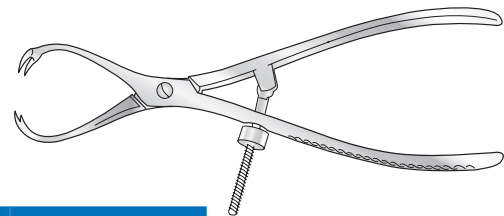

Code	Description
SC-OR/13	140mm long
SC-OR/014	185mm long
SC-OR/018	215mm long
SC-OR/019	275mm long

Farabeuf-Lambotte Bone Holding Forceps

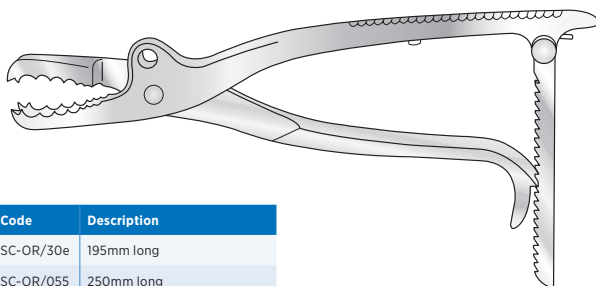

Code	Description
SC-OR/30e	195mm long
SC-OR/055	250mm long
SC-OR/30f	260mm long

Fergusson Bone Holding Forceps

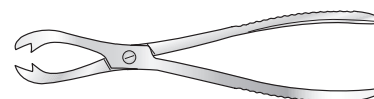

Code	Description
SC-OR/30	150mm long
SC-OR/30a	200mm long
SC-OR/30b	230mm long

Frosch Bone Holding Forceps

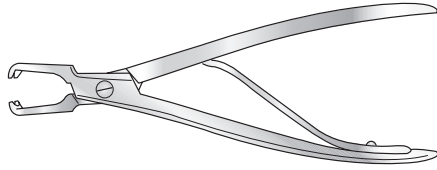

Code	Description
SC-OR/N061	180mm long

Sequestrum (Necrosis) Forcep

Straight, long fine jaws

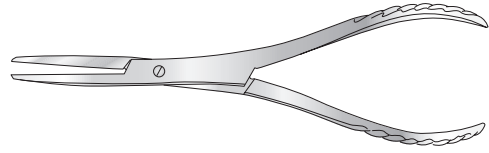

Code	Description
SC-OR/SEQ001	191mm long
SC-OR/SEQ002	203mm long

Joint Calcaneal Spreader

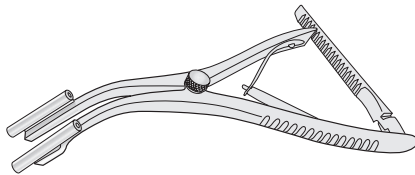

Code	Description
SC-OR/CAL001	40mm opening, 1.6mm ø, 170mm long

Calcaneal Spreader

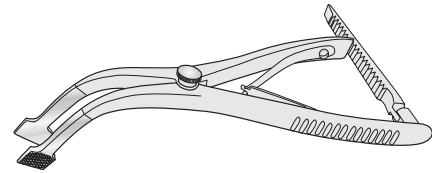

Code	Description
SC-OR/CAL002	40mm opening, 15mm wide tip, 70mm long

Inge Type Lamina Spreader

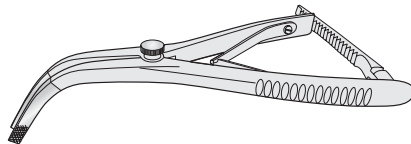

Code	Description
SC-OR/CAL003	40mm opening, no teeth, 5mm wide tip, 170mm long

Inge Type Lamina Spreader

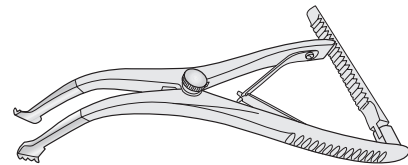

Code	Description
SC-OR/CAL004	Baby, 40mm opening, with teeth, 10mm wide tip, 160mm long
SC-OR/CAL004a	50mm opening, with teeth, 10mm wide tip, 240mm long

Harrison Bone Holding Forceps

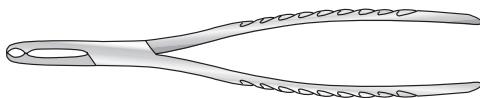

Code	Description
SC-OR/30d	190mm long

St Thomas Bone Holding Forceps

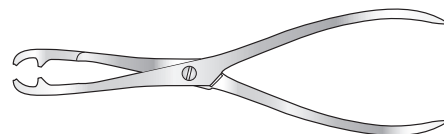

Code	Description
SC-OR/403c	182mm long

Bone Holding Forceps and Clamps

Burns Bone Holding Forceps

Box joint

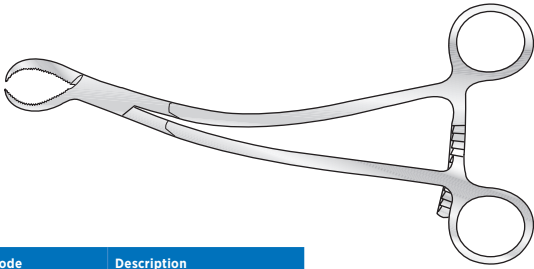

Code	Description
SC-OR/29a	200mm long

Scarf Type Clamp

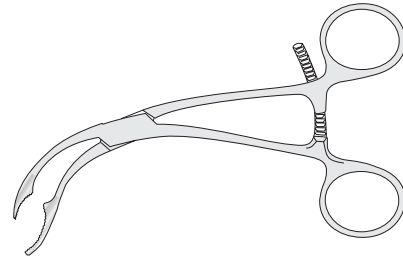

Code	Description
SC-OR/SCA	150mm long

Orthopaedic Grasping Forceps

Box joint

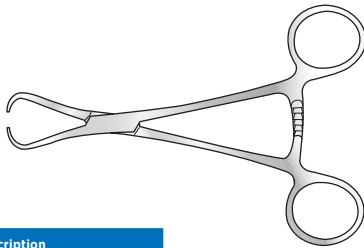

Code	Description
SC-OR/29b	125mm long
SC-OR/29c	165mm long

Lowman Bone Holding Clamp

Infant 125mm long
Child 175mm long
Adult 205mm long

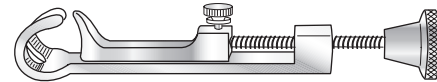

Code
SC-OR/28

Reduction Forcep

With adjustable lock

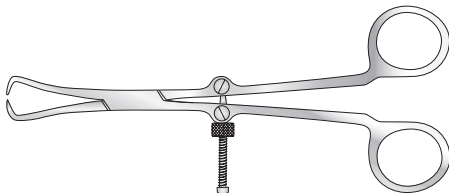

Code	Description
SC-OR/RED001a	Small, 135mm long
SC-OR/RED001b	Large, 168mm long

Parker Modified Lowman Bone Holding Clamp, Single

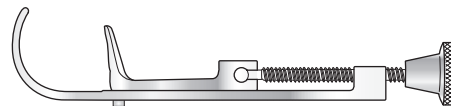

Code	Description
SC-OR/5644	160mm long

Verbrugge Bone Holding Forceps

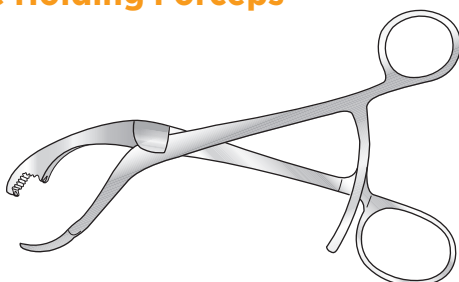

Code	Description
SC-OR/30c	180mm long

Parker Retractor

For use with Lowman clamp

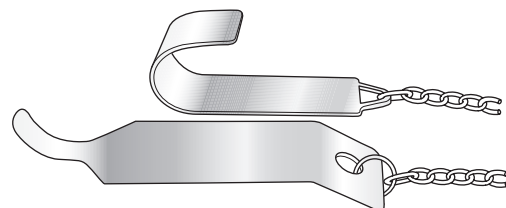

Code	Description
SC-OR/5643	Chain 850mm long

Haglund Plaster Spreader

Working part curved in right

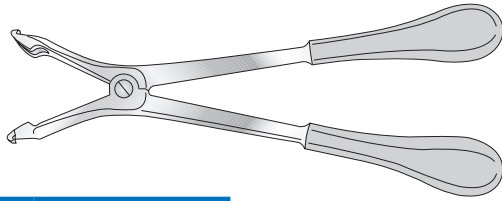

Code	Description
SC-OR/207	280mm long

Plaster Cutter

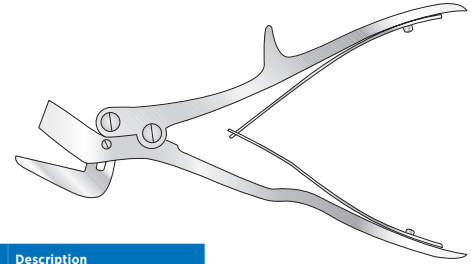

Code	Description
SC-OR/40	240mm long

Lawton Plaster Spreader

Working part curved in right

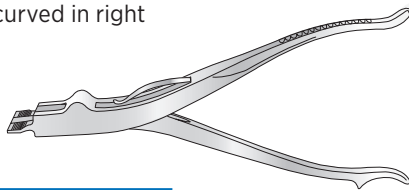

Code	Description
SC-OR/208	220mm long

Bohler Plaster Shears

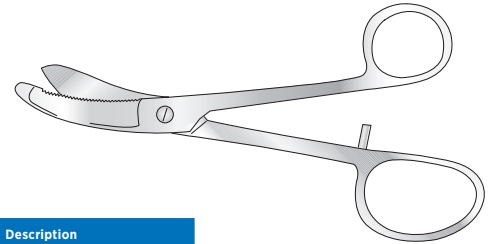

Code	Description
SC-OR/38	240mm long

Henning Plaster Spreader

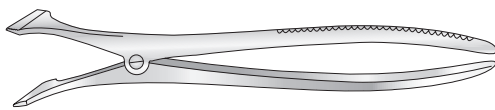

Code	Description
SC-OR/211	270mm long

Guys Plaster Shears



Code	Description
SC-OR/39	240mm long

Wolf Plaster Spreader



Code	Description
SC-OR/212	180mm long
SC-OR/329	250mm long

Engel Plaster Saw



Code	Description
SC-OR/40b	150mm long

Stille Type Plaster Shears



Code	Description
SC-OR/210	380mm long
SC-OR/210a	330mm long
SC-OR/210b	460mm long

Eccentric Plaster Shears

Without heavy serrated blade

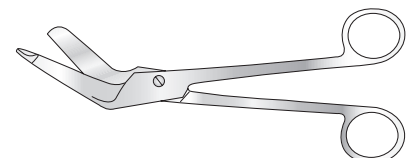

Code	Description
SC-OR/40a	190mm long

Bone Curettes

Bone Curette

Straight, 180mm long

Code	Description	Code	Description
SC-OR/075	Width 2mm	SC-OR/079	Width 10mm
SC-OR/076	Width 4mm	SC-OR/080	Width 12mm
SC-OR/077	Width 6mm	SC-OR/081	Width 14mm
SC-OR/078	Width 8mm	SC-OR/082	Width 16mm

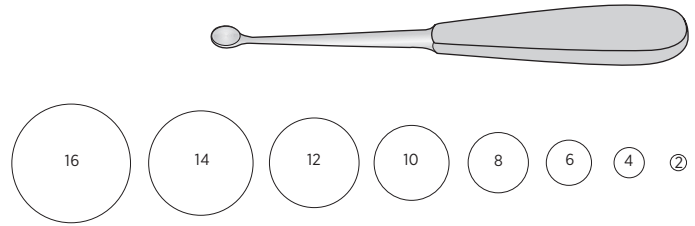

Bone Curette

Straight, 260mm long

Code	Description	Code	Description
SC-OR/083	Width 2mm	SC-OR/086	Width 8mm
SC-OR/084	Width 4mm	SC-OR/087	Width 10mm
SC-OR/085	Width 6mm	SC-OR/088	Width 12mm

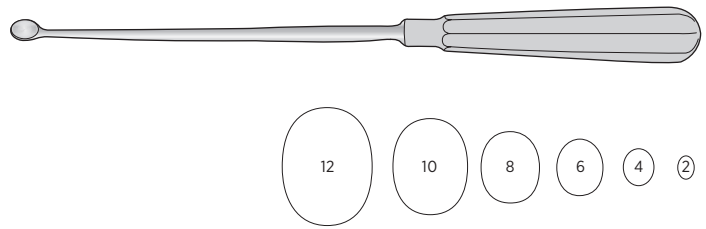

Bone Curette

Straight, 210mm long

Code	Description
SC-OR/089	Width 2mm
SC-OR/090	Width 4mm
SC-OR/091	Width 6mm
SC-OR/092	Width 8mm
SC-OR/093	Width 10mm
SC-OR/094	Width 12mm
SC-OR/095	Width 14mm
SC-OR/096	Width 16mm
SC-OR/097	Width 20mm

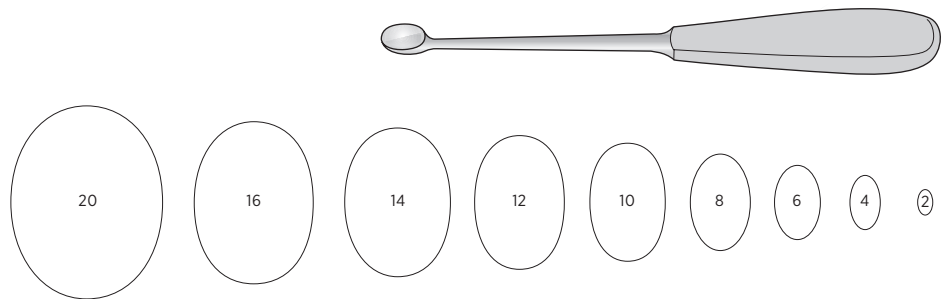

Busche Bone Curette

Angled, 250mm long

Code	Description
SC-OR/138	Width 3mm
SC-OR/139	Width 4mm
SC-OR/140	Width 5mm

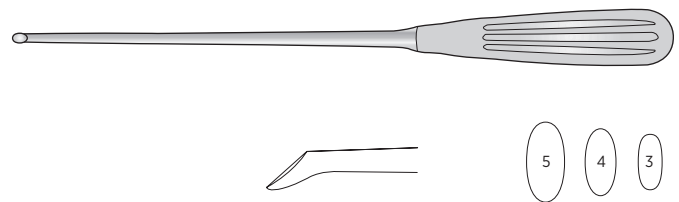

Bruns Bone Curette

225mm long

Straight

Code	Description
SC-OR/189	Width 3mm
SC-OR/190	Width 4mm
SC-OR/191	Width 5mm
SC-OR/192	Width 6mm
SC-OR/193	Width 7mm
SC-OR/194	Width 8mm

Angled

Code	Description
SC-OR/195	Width 3mm
SC-OR/196	Width 4mm
SC-OR/197	Width 5mm
SC-OR/198	Width 6mm
SC-OR/199	Width 7mm
SC-OR/200	Width 8mm

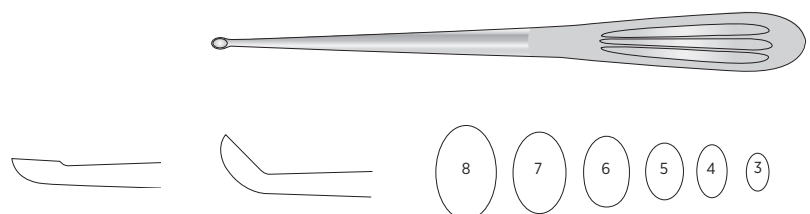

Gourdet Bone Curette

Straight, blunt
280mm long

Code	Description
SC-OR/157	Width 6mm
SC-OR/158	Width 8mm
SC-OR/159	Width 10mm
SC-OR/160	Width 12mm
SC-OR/161	Width 14mm

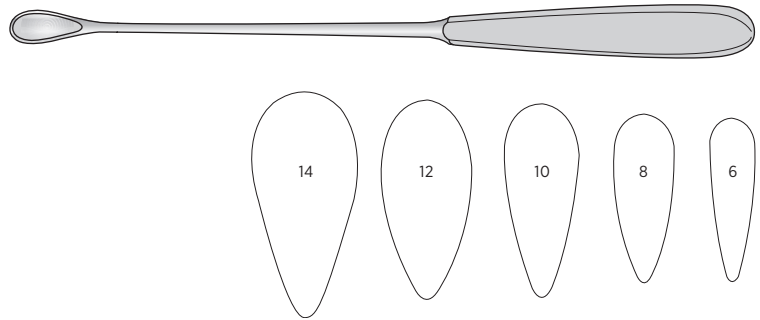

Shroeder Bone Curette

Straight, 310mm long

Code	Description
SC-OR/151	Width 6mm
SC-OR/152	Width 8mm
SC-OR/153	Width 10mm
SC-OR/154	Width 12mm
SC-OR/155	Width 14mm

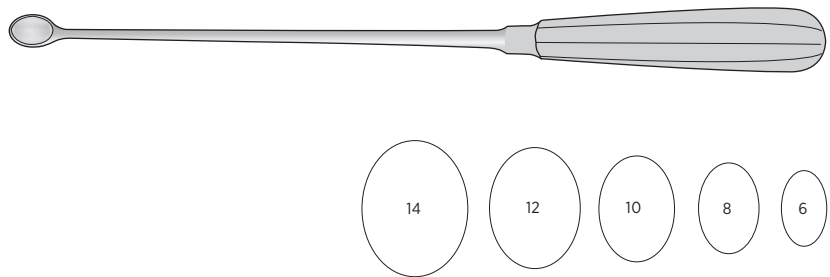

Simon Bone Curette

Straight, 240mm long

Code	Description
SC-OR/145	Width 6mm
SC-OR/146	Width 8mm
SC-OR/147	Width 10mm
SC-OR/148	Width 12mm
SC-OR/149	Width 14mm

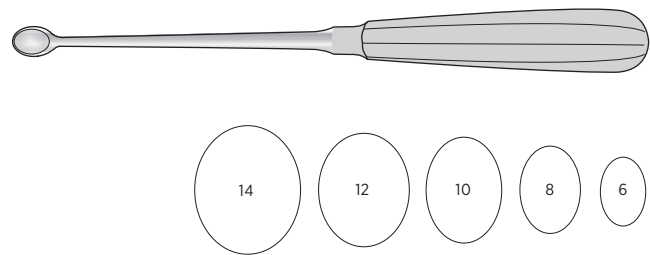

Spinal Curette

Oval, 205mm long

Code	Description	Code	Description
SC-OR/031a	Width 4mm	SC-OR/031e	Width 8mm
SC-OR/031b	Width 5mm	SC-OR/031f	Width 9mm
SC-OR/031c	Width 6mm	SC-OR/031g	Width 10mm
SC-OR/031d	Width 7mm	SC-OR/031h	Width 11mm

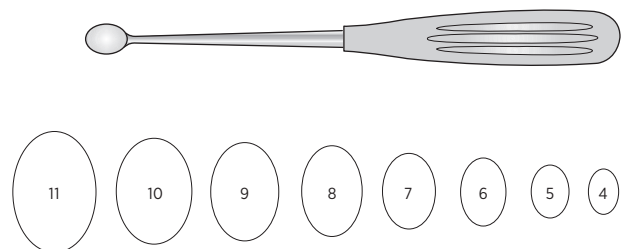

Bone Curettes

Volkman Bone Curette

Straight, 170mm long

Code	Description	Code	Description
SC-OR/112	Width 2mm	SC-OR/117	Width 8mm
SC-OR/113	Width 3mm	SC-OR/118	Width 10mm
SC-OR/114	Width 4mm	SC-OR/119	Width 12mm
SC-OR/115	Width 5mm	SC-OR/120	Width 14mm
SC-OR/116	Width 6mm		

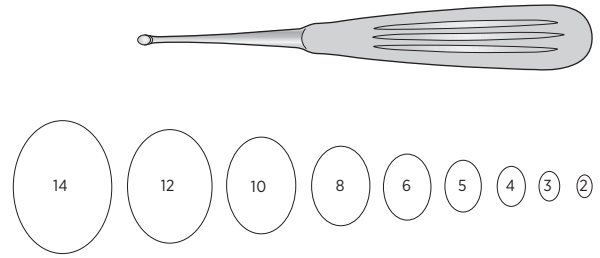

Volkman Bone Curette

Straight, 230mm long

Code	Description
SC-OR/SH.5687	Bowl width 10mm, bowl length 14.5mm



Wallich Bone Curette

Blunt

Code	Description
SC-OR/162	420mm long

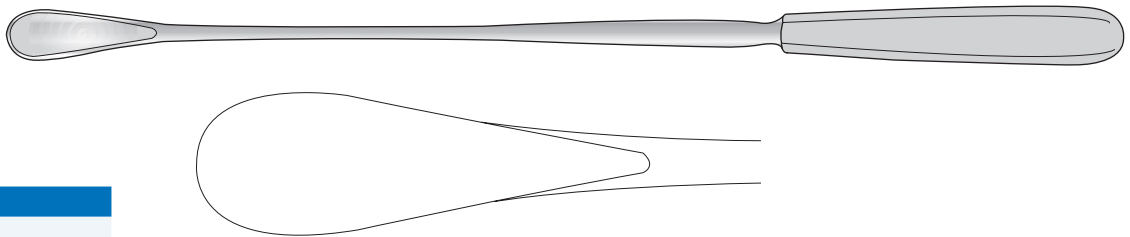

Williger Bone Curette

Straight, 170mm long

Code	Description
SC-OR/122	Width 3.5mm
SC-OR/123	Width 5.5mm

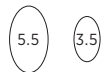

Charnley Bone Curette

With T handle,
380mm long

Code	Description
SC-OR/N040	Large, 20 x 14mm
SC-OR/N041	Medium, 17 x 12mm
SC-OR/N042	Small, 11 x 8mm

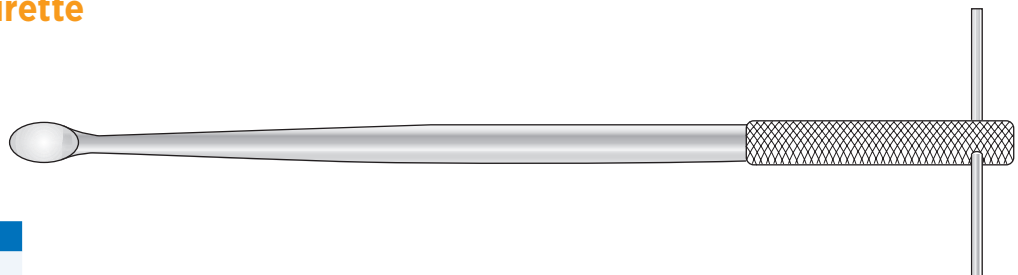

Sypert Bone Curette

Blue acetal "Suregrip" handle, 380mm long

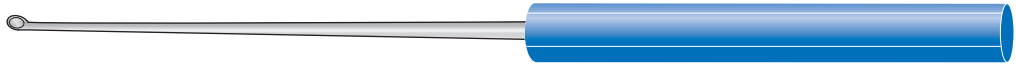

Straight

Code	Description
SC-OR/236	Width 3mm
SC-OR/237	Width 4mm
SC-OR/238	Width 5mm

Angled

Code	Description
SC-OR/240	Width 3mm
SC-OR/241	Width 4mm
SC-OR/245	Width 5mm



Bone Curette

Blue acetal "Suregrip" handle, 410mm long



Straight

Code	Description
SC-OR/249	Width 3mm
SC-OR/250	Width 4mm
SC-OR/251	Width 5mm

Angled

Code	Description
SC-OR/252	Width 3mm
SC-OR/253	Width 4mm
SC-OR/254	Width 5mm

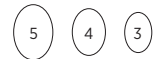

Caspar Bone Curette

Blue acetal "Suregrip" handle, 220mm long

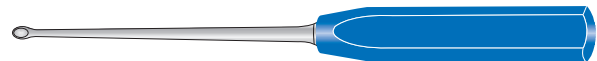

Straight

Code	Description
SC-OR/230	Width 3.5mm
SC-OR/231	Width 4.5mm
SC-OR/232	width 5.5mm

Angled

Code	Description
SC-OR/233	Width 3.5mm
SC-OR/234	Width 4.5mm
SC-OR/235	Width 5.5mm

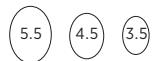

Bone Curette

Blue acetal "Suregrip" handle, 270mm long, straight



Code	Description
SC-OR/226	Width 4mm
SC-OR/227	Width 6mm
SC-OR/228	Width 8mm
SC-OR/229	Width 10mm

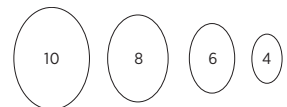

Bone Curettes

Capener Spoon

Blue acetal "Suregrip" handle 285mm long

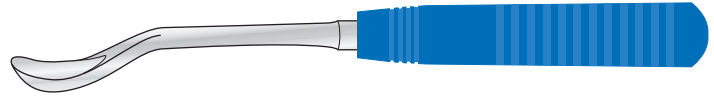

Code	Description
SC-OR/389a	Width 16mm
SC-OR/389b	Width 20mm

Capener Lamina Curette

Blue acetal "Suregrip" handle 300mm long

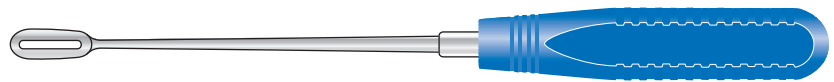

Code	Description
SC-OR/389c	12 x 32mm
SC-OR/389d	6 x 18mm

Stanley Boyd Curette

Double ended



Code	Description
SC-OR/162a	Small - 50mm long
SC-OR/162b	Medium - 200mm long
SC-OR/162c	Large - 250mm long



Volkman Bone Scoop

Double-ended, straight



Code	Description
SC-OR/31	175mm long
SC-OR/213	220mm long
SC-OR/175	220mm long

Martini Bone Curette

Shown at half size
double-ended, straight 140mm long



Code	Description
SC-OR/170	Small and medium
SC-OR/171	Medium and large

Lane Bone Lever

240mm long

6mm

Code	Description
SC-OR/N011	Slight curve
SC-OR/N012	Full curve

8mm

Code	Description
SC-OR/N013	Slight curve
SC-OR/N014	Full curve



Lane Bone Lever

For small bones

Code	Description
SC-OR/N015	10mm wide, 265mm long



Lane Bone Lever

For small bones, serrated end

Code	Description
SC-OR/N016	10mm wide, 260mm long

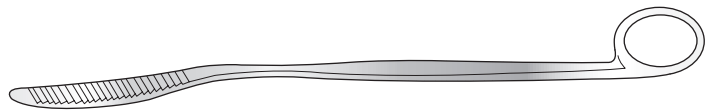

Trethowan Bone Lever

Ring handle

Code	Description
SC-OR/N017	220mm long



Watson-Jones Bone Lever

Code	Description
SC-OR/N054	275mm long



Bankhart Bone Lever

Code	Description
SC-OR/SH.5315	300mm long



Retractors

Hip Set

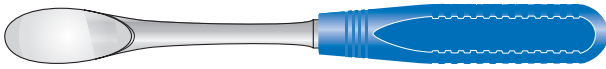

Femoral Dislocation Lever 285mm

Code	Description
SC-OR/N059A	Spoon elevator 25mm with blue acetal suregrip handle - large

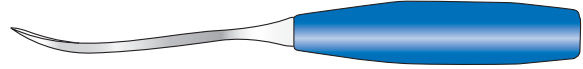

Curved Osteotome 260mm

Code	Description
SC-OR/N059D	With blue acetal suregrip handle - 2

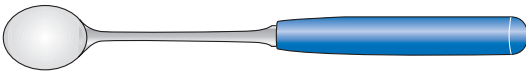

Muller Curette 240mm

Code	Description
SC-OR/N059B	Curette 27mm with blue acetal suregrip handle - large



Small Gouge 240mm

Code	Description
SC-OR/N059E	8mm cranked blue acetal suregrip handle



Muller Curette 270mm

Code	Description
SC-OR/N059C	Curette 9mm with blue acetal suregrip handle - small

Charnley Initial Incision Retractor

Code	Description
SC-OR/N038a	Frame only
SC-OR/N038b	Weight only, 75mm x 50mm ø
SC-OR/N038s	Goal post pins and chain

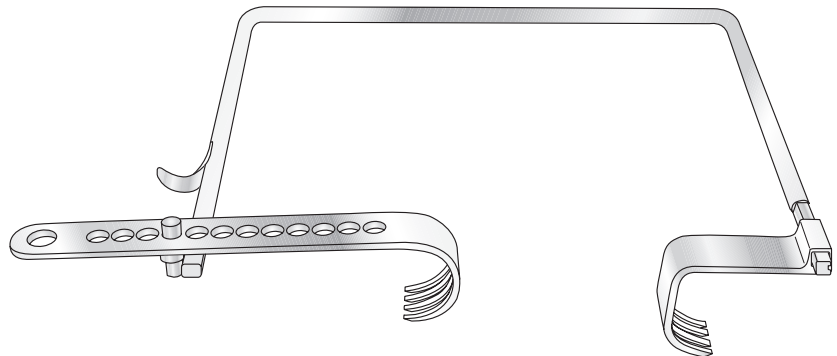

Short blades

Code	Description
SC-OR/N038r	Short blade, 25mm deep
SH006084	Short blade, 35mm deep
SC-OR/N038c	Short blade, 50mm deep
SC-OR/N038l	Short blade, 65mm
SC-OR/N038e	Short blade, 75mm deep
SC-OR/N038q	Short blade, 80mm deep
SC-OR/N038g	Short blade, 100mm deep
SH003879	Short blade, 125mm
SH003880	Short blade, 150mm

Long blades

Code	Description
SH006085	Long blade, 35mm deep
SC-OR/N038d	Long blade, 50mm deep
SC-OR/N038k	Long blade, 65mm
SC-OR/N038p	Long blade, 70mm deep
SC-OR/N038f	Long blade, 75mm deep
SC-OR/N038h	Long blade, 100mm deep
SH003877	Long blade, 125mm
SH003878	Long blade, 150mm
SC-OR/N038m	Long round blade, 50mm deep

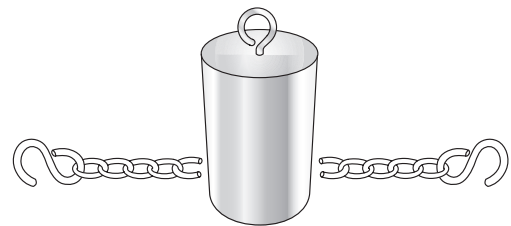

Travers Retractor

Self retaining, internal rack, 210mm long

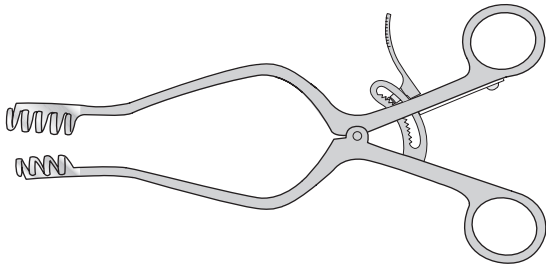

Code	Description
SC-GI/323	4 x 5 teeth, 95mm fully open

Jackson Burrows Retractor

Self retaining

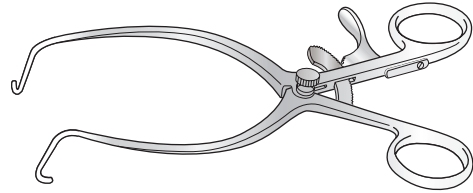

Code	Description
SC-GI/377	175mm

West Retractor

Self retaining, 140mm long

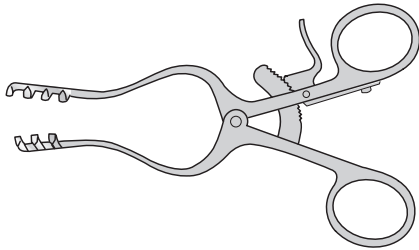

Code	Description
SC-GI/326	3 x 4 teeth, 60mm fully open
SC-GI/326cr	3 x 4 teeth, 60mm fully open, with cam rack

Norfolk and Norwich Retractor

4 x 5 teeth 50mm blades x 223mm long

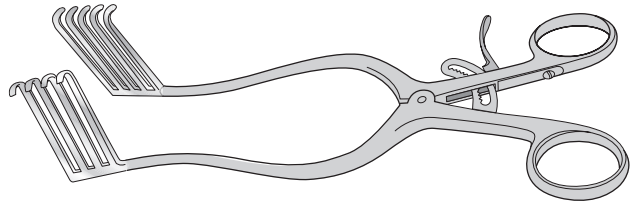

Code	Description
SC-GI/325	Standard rack

Retractors, Dissecting Forceps and Hooks



Jackson Burrows Hand Retractor

225mm long

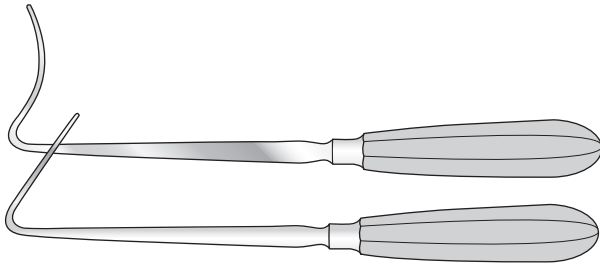

Code	Description
SC-OR/N050	Narrow curve, 13mm blade
SC-OR/N050a	Broad, angular, 20mm blade

Kocher Bone Hook

220mm long

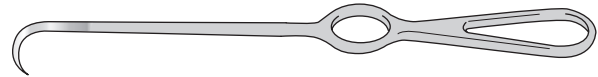

Code	Description
SC-OR/N036	Sharp
SC-OR/N036a	Blunt

Ballance (Volkman) Retractor

203mm long

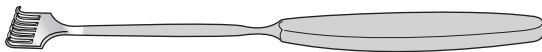

Sharp

Code	Description
SC-GI/463	1 prong
SC-GI/463a	2 prong
SC-GI/463b	3 prong
SC-GI/463c	4 prong
SC-GI/463d	6 prong

Blunt

Code	Description
SC-GI/463e	1 prong
SC-GI/463f	2 prong
SC-GI/463g	3 prong
SC-GI/463h	4 prong
SC-GI/463i	6 prong

Langenbeck Bone Hook

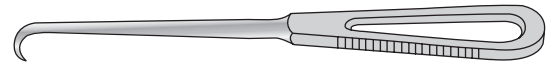

Code	Description
SC-OR/391	200mm long

Dislocation Hook

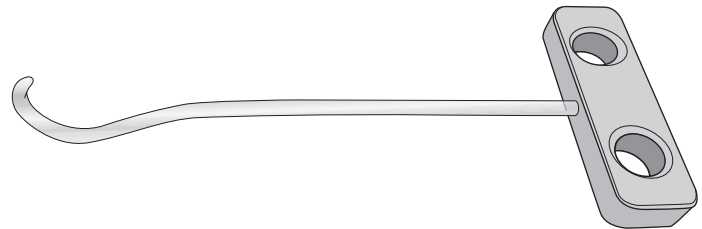

Code	Description
SC-OR/SH-5703	253mm long

Jackson Burrows Dissecting Forcep

140mm long

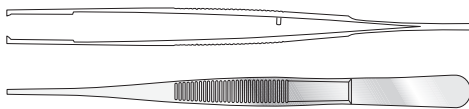

Code	Description
SC-OR/N037	Tongue and groove only
SC-OR/N037a	Tongue and groove, 1-2 teeth

Dislocation Hip Hook

Blue acetal "Suregrip" handle

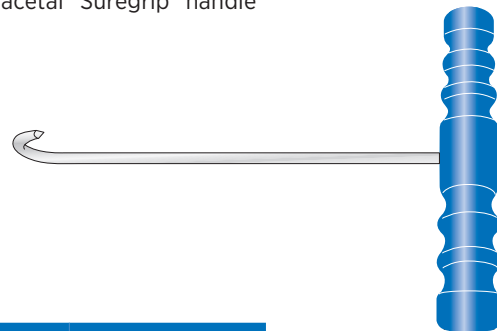

Code	Description
SC-OR/420	185mm long

Charnley-McIndoe Dissecting Forceps

150mm long

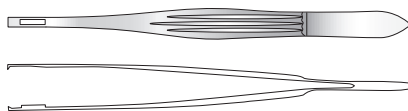

Code	Description
SC-OR/N045a	2-3 teeth

Key Raspatories

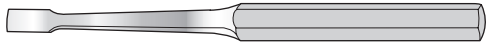

Code	Description
SC-OR/310	Width 6.4mm 180mm long
SC-OR/313	Width 9.5mm 190mm long
SC-OR/311	Width 12.7mm 190mm long
SC-OR/312	Width 19mm 200mm long
SC-OR/314	Width 25.4mm 210mm long

Lambotte Raspatory

205mm Long

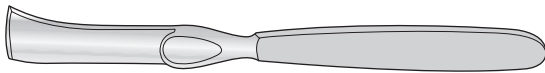

Code	Description
SC-OR/242	Width 10mm
SC-OR/243	Width 15mm
SC-OR/244	Width 20mm

Paton Bone Burr

Satin handle, 155mm long

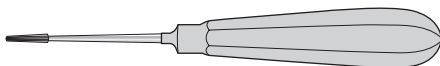

Code	Description
SC-OR/403	3.5mm ø x 17mm
SC-OR/403a	4.5mm ø x 17mm
SC-OR/403b	5.0mm ø x 17mm

Robert Jones Rugine

Convex sharp edge, fan shaped end, with solid pistol handle

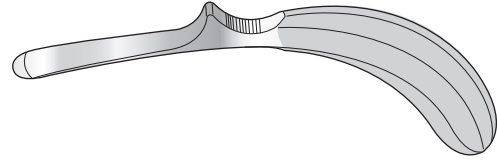

Code	Description
SC-OR/N035	185mm long

Mitchell Rugine

Straight, sharp edge, fan shaped, hollow handle

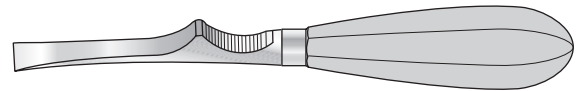

Code	Description
SC-OR/N034	210mm long

Farabeuf Rugine

Curved end, chisel edge, hollow handle

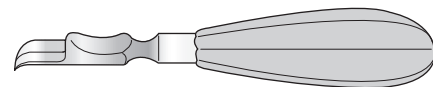

Code	Description
SC-OR/N033	160mm long

Osteotomes, Chisels and Gouges

Lexer Osteotome

Blue acetal "Suregrip" handle, 180mm long



Code	Description
SC-OR/SH5347a	4mm

Capener Osteotome

Blue acetal "Suregrip" handle, 250mm long

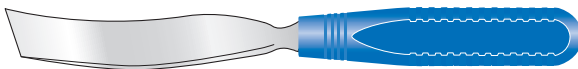

Shallow curved

Code	Description
SC-OR/384	Width 6mm
SC-OR/385	Width 10mm
SC-OR/386	Width 12mm
SC-OR/387	Width 15mm
SC-OR/388	Width 20mm
SC-OR/389	Width 25mm
SC-OR/390	Width 30mm

Acute curved

Code	Description
SC-OR/390a	Width 6mm
SC-OR/390b	Width 10mm
SC-OR/390c	Width 15mm
SC-OR/390d	Width 20mm
SC-OR/390e	Width 25mm

Capener Osteotome

Blue acetal "Suregrip" handle, straight, 255mm long

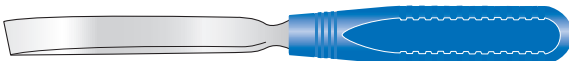

Code	Description	Code	Description
SC-OR/374	Width 6mm	SC-OR/379	Width 15mm
SC-OR/375	Width 8mm	SC-OR/380	Width 18mm
SC-OR/376	Width 10mm	SC-OR/381	Width 20mm
SC-OR/377	Width 12mm	SC-OR/382	Width 25mm
SC-OR/378	Width 13mm	SC-OR/383	Width 30mm

Capener Chisel

Blue acetal "Suregrip" handle straight, 250mm long

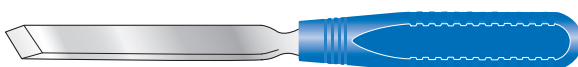

Code	Description	Code	Description
SC-OR/368	Width 6mm	SC-OR/371	Width 15mm
SC-OR/369	Width 10mm	SC-OR/372	Width 20mm
SC-OR/370	Width 12mm	SC-OR/373	Width 25mm

Capener Lamina Gouge

Blue acetal "Suregrip" handle, straight, 265mm long

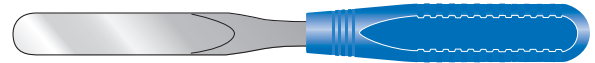

Code	Description
SC-OR/362	Width 6mm
SC-OR/363	Width 10mm
SC-OR/364	Width 12mm

Code	Description
SC-OR/365	Width 15mm
SC-OR/366	Width 20mm
SC-OR/367	Width 25mm

Capener Lamina Gouge

Cranked, blue acetal "Suregrip" handle, 250mm long

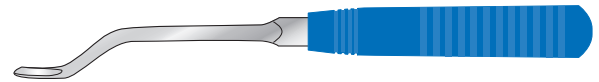

Code	Description
SC-OR/373c	Width 6mm
SC-OR/373d	Width 8mm
SC-OR/373j	Width 10mm
SC-OR/373e	Width 11mm
SC-OR/373f	Width 16mm
SC-OR/373k	Width 17mm

With reversed edge

Code	Description
SC-OR/373cre	Width 6mm
SC-OR/373dre	Width 8mm
SC-OR/373jre	Width 10mm
SC-OR/373ere	Width 11mm
SC-OR/373fre	Width 16mm
SC-OR/373kre	Width 17mm

OTHER LENGTHS AND SIZES AVAILABLE

Capener Lamina Gouge

Swan neck, blue acetal "Suregrip" handle, 250mm long

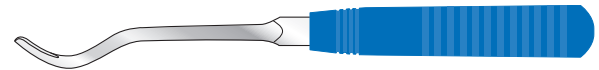

Code	Description
SC-OR/373g	Width 8mm

Capener Lamina Gouge

Reverse cranked, blue acetal "Suregrip" handle, 245mm long



Code	Description
SC-OR/373ar	Width 11mm
SC-OR/373nr	Width 16mm
SC-OR/373jr	Width 17mm

Code	Description
SC-OR/3730r	Width 6mm
SC-OR/3731r	Width 8mm
SC-OR/373mr	Width 10mm

Read Osteotome

Serrated head
180mm long



Code	Description
SC-OR/335	Width 4mm
SC-OR/336	Width 5mm

Read Gouge

Serrated head, 180mm long



Code	Description
SC-OR/344	Width 2mm
SC-OR/345	Width 3mm
SC-OR/346	Width 4mm
SC-OR/347	Width 5mm

Code	Description
SC-OR/341	Width 6mm
SC-OR/342	Width 7mm
SC-OR/343	Width 8mm

Read Chisel

Serrated head, 180mm long



Code	Description
SC-OR/337	Width 2mm
SC-OR/338	Width 3mm
SC-OR/339	Width 4mm
SC-OR/340	Width 5mm

Code	Description
SC-OR/341	Width 6mm
SC-OR/342	Width 7mm
SC-OR/343	Width 8mm

Swedish Pattern Osteotome

200mm long

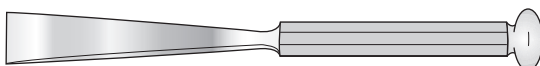

Code	Description
SC-OR/348	Width 10mm
SC-OR/349	Width 15mm
SC-OR/350	Width 20mm
SC-OR/351	Width 25mm
SC-OR/352	Width 30mm

With tungsten carbide edge

Code	Description
SC-OR/348tc	Width 10mm
SC-OR/349tc	Width 15mm
SC-OR/350tc	Width 20mm
SC-OR/351tc	Width 25mm
SC-OR/352tc	Width 30mm

Swedish Pattern Chisel

200mm long

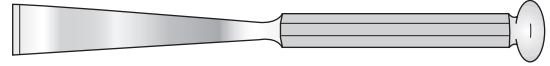

Code	Description
SC-OR/353	Width 10mm
SC-OR/354	Width 15mm
SC-OR/355	Width 20mm
SC-OR/356	Width 25mm
SC-OR/357	Width 30mm

With tungsten carbide edge

Code	Description
SC-OR/355tc	Width 20mm
SC-OR/356tc	Width 25mm
SC-OR/357tc	Width 30mm
SC-OR/356tc	Width 25mm
SC-OR/357tc	Width 30mm

Swedish Pattern Gouge

200mm long

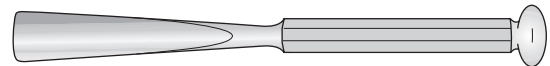

Code	Description
SC-OR/358	Width 10mm
SC-OR/359	Width 15mm
SC-OR/360	Width 20mm
SC-OR/361	Width 25mm

With tungsten carbide edge

Code	Description
SC-OR/358tc	Width 10mm
SC-OR/359tc	Width 15mm
SC-OR/360tc	Width 20mm
SC-OR/361tc	Width 25mm

Lambotte Osteotome

230mm long



Straight

Code	Description
SC-OR/392	2mm wide
SC-OR/392a	4mm wide
SC-OR/392b	7mm wide
SC-OR/392c	15mm wide
SC-OR/392d	20mm wide
SC-OR/392e	25mm wide
SC-OR/392f	30mm wide
SC-OR/392g	38mm wide
SC-OR/392h	44mm wide
SC-OR/392i	50mm wide

Curved

Code	Description
SC-OR/392j	15mm wide
SC-OR/392k	20mm wide
SC-OR/392m	25mm wide
SC-OR/392n	30mm wide
SC-OR/392o	38mm wide
SC-OR/392p	40mm wide
SC-OR/392q	44mm wide
SC-OR/392r	50mm wide

Osteotomes, Chisels and Gouges

Albee Osteotome

190mm long

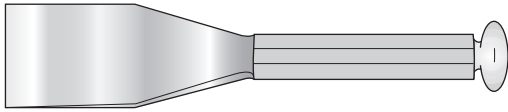

Code	Description
SC-OR/NO62a	Width 38mm
SC-OR/NO62b	Width 50mm

Small Gouges

150mm long



Code	Description
SC-OR/16-4	4mm wide
SC-OR/16-6	6mm wide
SC-OR/16-8	8mm wide

Moore Hollow Osteotome

Rectangular, for curved standard stems



Code	Description
SC-OR/N008	135mm long
SC-OR/N008a	255mm long

Box Chisel

Blue acetal "Suregrip" handle,
285mm long



Code
SC-OR/N008b

Small Osteotomes

150mm long



Code	Description
SC-OR/14-4	4mm wide
SC-OR/14-6	6mm wide
SC-OR/14-8	8mm wide

Alexander Gouge

Straight, 170mm long



Code	Description
SC-OR/290	Width 5mm
SC-OR/291	Width 7mm

Code	Description
SC-OR/292	Width 9mm
SC-OR/293	Width 11mm

Small Chisels

150mm long



Code	Description
SC-OR/18-4	4mm wide
SC-OR/18-4	6mm wide
SC-OR/18-4	8mm wide

Partsch Gouge

Straight



140mm long

Code	Description
SC-OR/283	Width 3mm
SC-OR/284	Width 4mm
SC-OR/285	Width 5mm
SC-OR/286	Width 6mm

170mm long

Code	Description
SC-OR/294	Width 3mm
SC-OR/287	Width 4mm
SC-OR/295	Width 5mm
SC-OR/288	Width 6mm
SC-OR/289	Width 7mm

Wire Cutting Pliers

Tungsten carbide edge, for cutting up to and including 6mm \varnothing

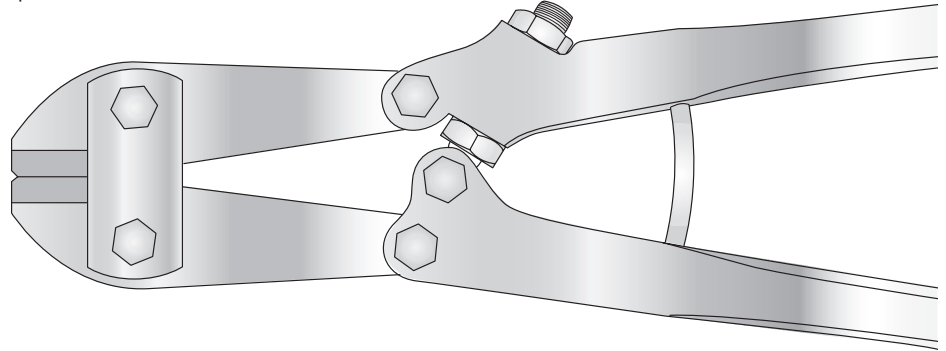

Code	Description
SC-OR/258	450mm long
SC-OR/259	560mm long

Wire Cutting Pliers

Tungsten carbide edge, for cutting Kirschner wires up to and including 5.5mm \varnothing

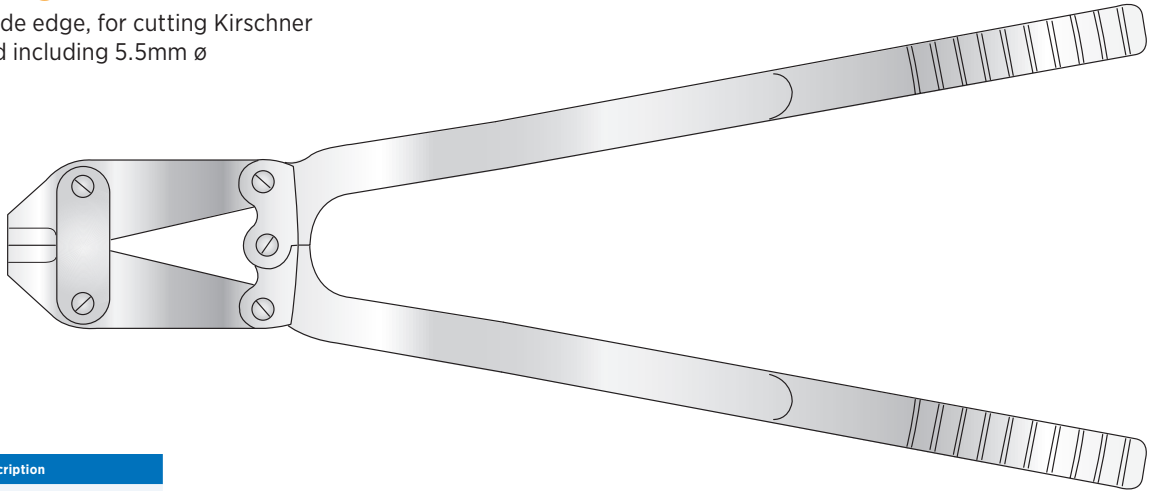

Code	Description
SC-OR/07a	480mm long

Wire Cutting Pliers

Tungsten carbide edge, for cutting Kirschner wires up to 4mm \varnothing

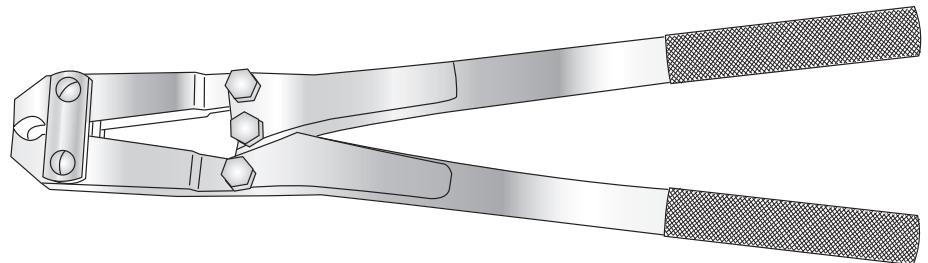

Code	Description
SC-OR/261	380mm long

Wire Cutters and Pliers

Top Cutter

Gold handles, tungsten carbide edge, for cutting Kirschner wire

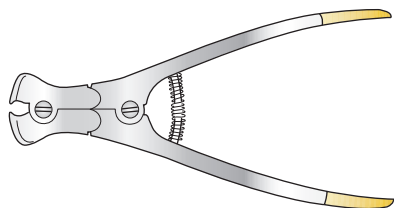

Code	Description
SC-OR/06	Up to 2.5mm, 215mm long
SC-OR/06a	Up to 1.5mm, 145mm long

Side Cutter

Gold handles, tungsten carbide edge, jaws have rounded edges, for cutting Kirschner wires

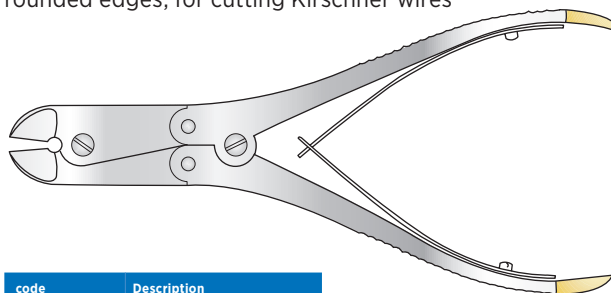

code	Description
SC-OR/331	Up to 2.5mm ø, 230mm long
SC-OR/332	Up to 2.2mm ø, 215mm long
SC-OR/333	Up to 1.5mm ø, 145mm long

Top and Side Cutter

Small, gold handles, tungsten carbide edge, for cutting Kirschner wires up to 1.5mm ø

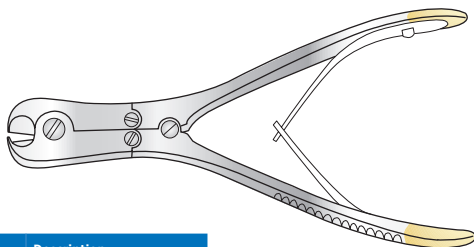

Code	Description
SC-OR/06b	175mm long

Wire Cutting Pliers

Gold handles, tungsten carbide edge, 120mm long

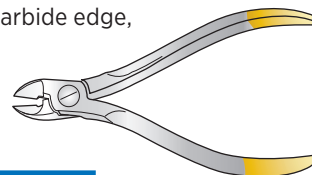

Code	Description
SC-OR/263	For wire up to 0.2mm ø
SC-OR/267	For wire up to 0.3mm ø
SC-OR/262	For wire up to 0.5mm ø
SC-OR/269	For wire up to 0.5mm ø 115mm long
SC-OR/268	For wire up to 0.7mm ø

Side Cutter

Compound action, angled tungsten carbide jaw, gold handles, for Kirschner wire up to 1.6mm ø

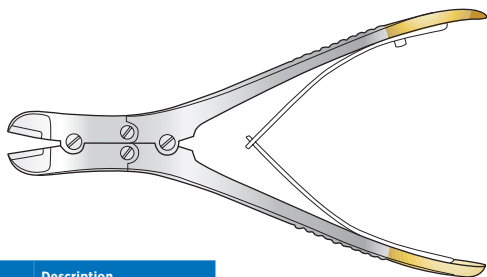

Code	Description
SC-OR/N060	180mm long

Orthopaedic Plier/Cutter

Stainless steel

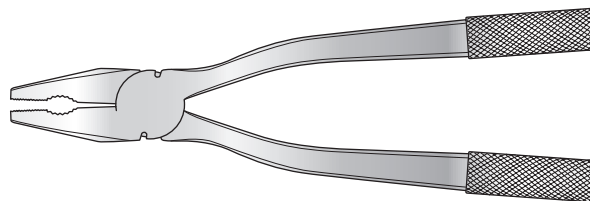

Code	Description
SC-OR/271b	180mm long
SC-OR/271c	220mm long

Side Cutter

Gold handles, tungsten carbide edge, for cutting Kirschner wires up to 1.5mm ø

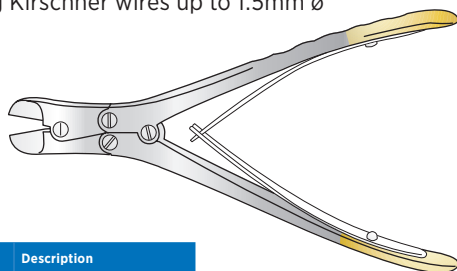

Code	Description
SC-OR/260	170mm long

Bone Plate Bender/Wire Cutter Pliers

For nipping and breaking off soft wire only
Not suitable for Kirschner wires

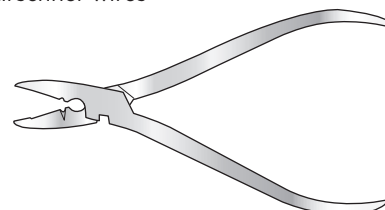

Code	Description
SC-OR/32a	150mm long

Pliers for Wire

175mm long

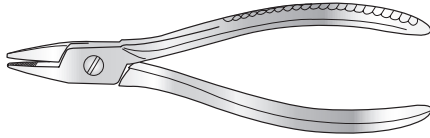

Code
SC-OR/273



Code
SC-OR/275

Pliers for Bone Burrs

190mm long

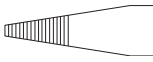
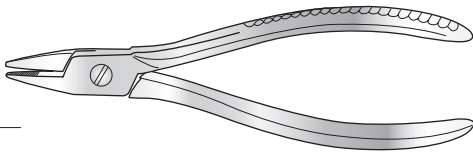

Code
SC-OR/274

Orthopaedic Plier/Cutter

Stainless steel, tungsten carbide edge, for cutting Kirschner wire up to 1.6mm

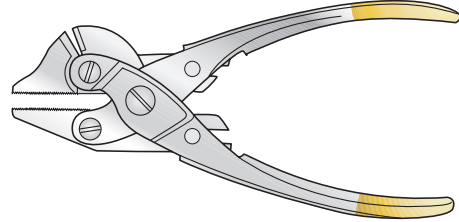

Code	Description
SC-OR/271a	TC 180mm long
SC-OR/271b	Non TC for cutting soft wire only, max cut 1.6mm, 180mm long

Orthopaedic Pliers

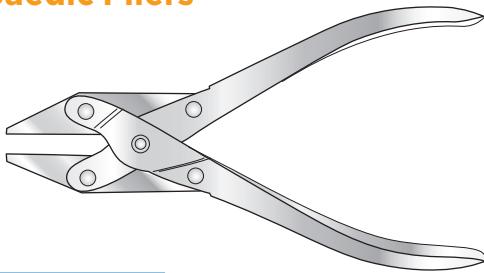

Code	Description
SC-OR/49b	185mm

Mole Grip Type Wrench

Stainless steel

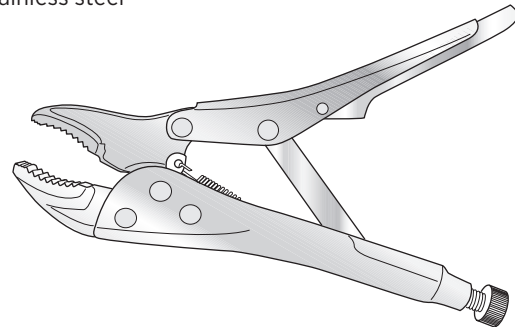

Code	Description
SC-OR/N052	190mm long

Accessories

Wire Twister Biomet Type



Code	Description
SC-OR/49a	150mm long

Martin Cartilage Forceps

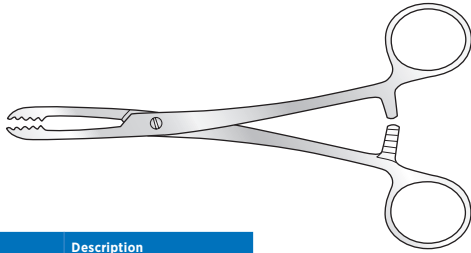

Code	Description
SC-OR/393	180mm long

Charnley Suture Forcep

Slotted, 1-2 teeth

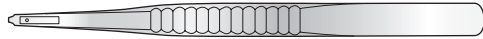

Code	Description
SC-OR/N045	180mm long

Suture Wire Cutting Scissors

Angled to cut soft wire only, max cut 1.2mm

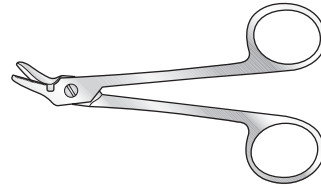

Code	Description
SC-OR/07b	120mm long

Suture Wire Cutting Scissors

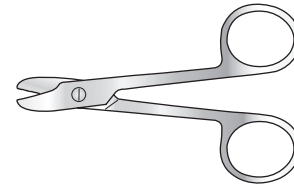

Code	Description
SC-OR/07c	110mm long

Mallet

With serrated head, 170mm long



Code	Description
SC-OR/023	190 grams

Mallet

Blue acetal, 240mm long

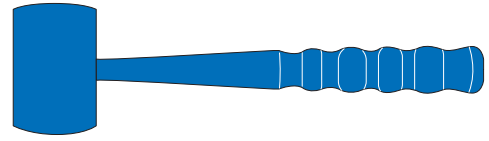

Code	Description
SC-OR/LE1001	340 grams, vertical end

Mallet

Blue acetal "Suregrip" handle, 275mm long

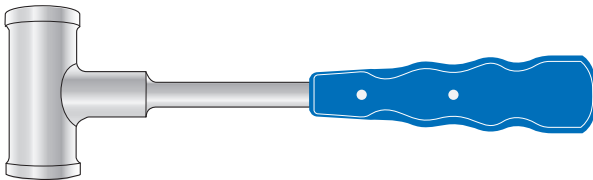

Code
SC-OR/270A-BH

Mallet

Blue acetal, 255mm long

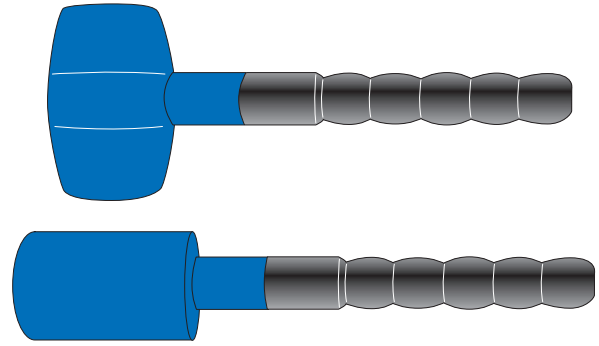

Code	Description
SC-OR/22a	520 grams, vertical end
SC-OR/22	650 grams, horizontal end

Mallet

Stainless steel, 270mm long

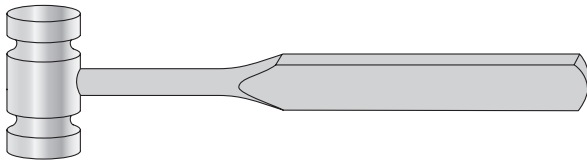

Code	Description
SC-OR/270	640 grams
SC-OR/271	1020 grams

Heath Mallet

Stainless steel, 135mm long

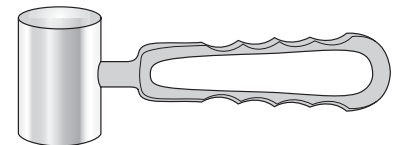

Code	Description	Code	Description
SC-OR/N044c	650 grams	SC-OR/N044	1150 grams
SC-OR/N044b	920 grams	SC-OR/N044a	1340 grams

Mallet

Stainless steel, with pistol grip*
240mm long

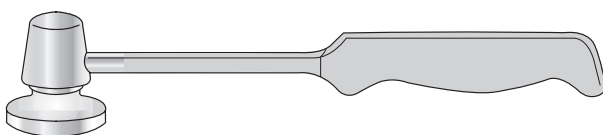

Code	Description
SC-OR/20	580 grams

*ALSO AVAILABLE WITH
 BLUE ACETAL HANDLE

Royal Cornwall Mallet

Stainless steel, with extended handle and strong welded head, 190mm long

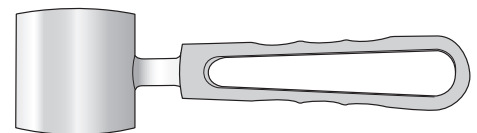

Code	Description
SC-OR/N044rc	1000 grams

Mallets

Orthopaedic Mallet

Surgical Holdings pattern, stainless steel, 170mm long

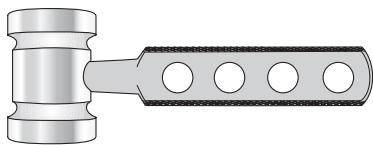

Code	Description
SC-OR/N055b	800 grams
SC-OR/N055	880 grams
SC-OR/N055a	1020 grams

Orthopaedic Mallet

Stainless steel, Surgical Holdings pattern, one flat and one domed end, 180mm long

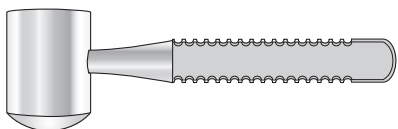

Code	Description
SC-OR/272a	960 grams
SC-OR/272c	750 grams

Toffee Hammer

Stainless steel, one plain and one serrated side, 190mm long

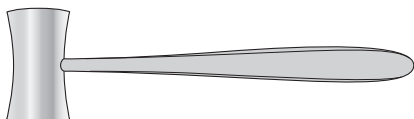

Code	Description
SC-OR/N047	280 grams

Ombredanne Mallet

Stainless steel, one flat and one domed end

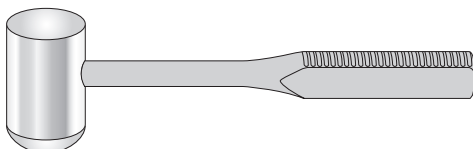

Code	Description
SC-OR/272	950 grams, 240mm long
SC-OR/272b	1110 grams, 270mm long

Collin Mallet

Stainless steel, 205mm long

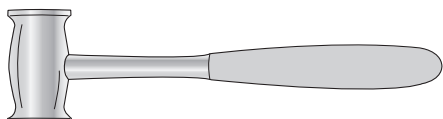

Code	Description
SC-OR/23	270 grams

Kelsey Fry Mallet

With renewable acetal ends, 190mm long

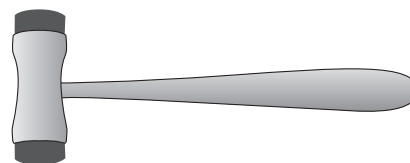

Code	Description
SC-OR/N047a	280 grams
SC-OR/N048	Replacement end - pair

Surgical Holdings Orthopaedic Mallet

Stainless steel with blue acetal "Suregrip" handle 270mm long

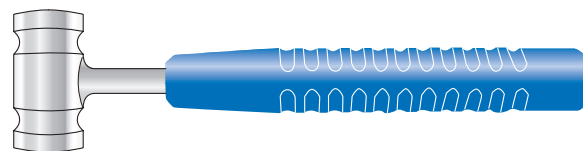

Code	Description
SC-OR/410	720 grams
SC-OR/411	800 grams

Code	Description
SC-OR/412	900 grams
SC-OR/413	970 grams

Surgical Holdings Orthopaedic Mallet

Stainless steel with blue acetal "Suregrip" handle 200mm long

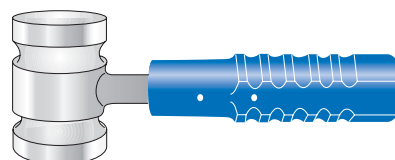

Code	Description
SC-OR/414BH	660 grams
SC-OR/415BH	790 grams

Code	Description
SC-OR/416BH	1020 grams
SC-OR/417BH	1400 grams

Surgical Holdings Mallet

Stainless steel with blue acetal "Suregrip" handle domed faced head, 200mm long

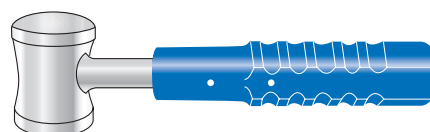

Code	Description
SC-OR/418BH	650 grams

Putti Raspatory



Code	Description
SC-OR/12	300mm long

OTHER SHAPES AND CONFIGURATIONS ON REQUEST

Bone File and Raspatory

Stainless steel



Code	Description
SC-OR/12a	215mm long

Austin Moore Type Raspatory

Including tommy bar,
295mm long

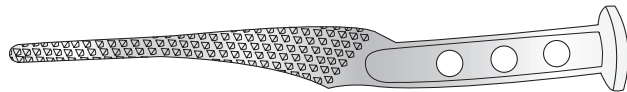

Code	Description
SC-OR/HP001	Standard
SC-OR/HP002	Narrow (not illustrated)

Thompson Type Raspatory

Including tommy bar

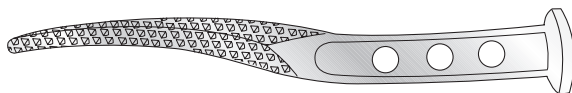

Many other types available

Supply a drawing of the prosthesis - we will make the rasp in any batch size you require. The teeth will be chipped up at 0.75mm per face over and above the size of the prosthesis stem, to allow for cementing.

Code	Description
SC-OR/HP003	270mm long

Miller Bone File

180mm long

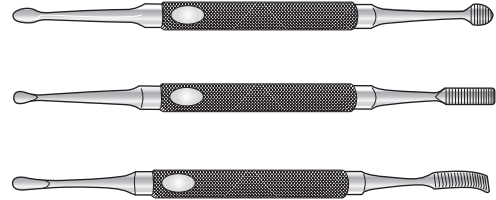

Code	Description
SC-OR/318	Short end
SC-OR/319	Slight curve
SC-OR/322	Full curve

McGoey Punch

Double ended, 220mm long

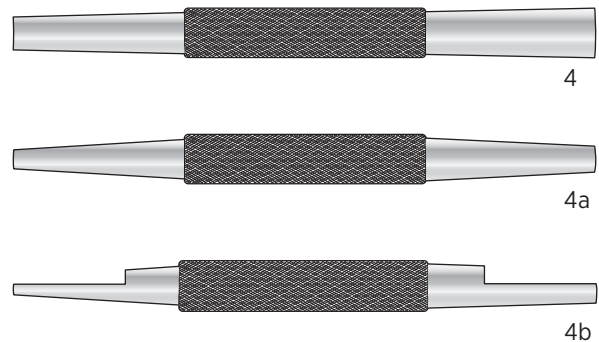

Code	Description
SC-OR/N04	13 x 19mm
SC-OR/N04a	6 x 10mm
SC-OR/N04b	13 x 6mm half round

Smillie Bone Punch



Head size 15 x 19.5mm

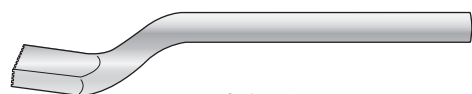

Head size 9.5 x 15.5mm

Code	Description
SC-OR/N018	Straight 140mm long
SC-OR/N019	Cranked 175mm long

Pushers, Impactors and Skids

Charnley Cup Pusher

With nylon head

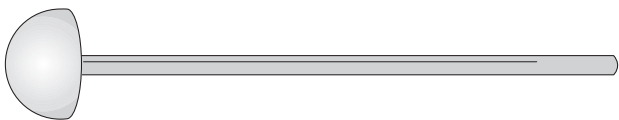

Code	Description
SC-OR/N020	295mm long

Hardinge Cement Restrictor

With T handle

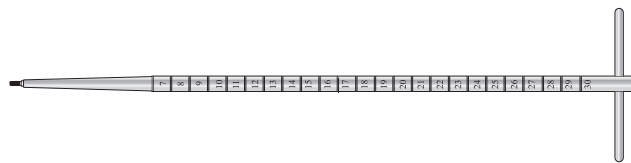

Code	Description
SC-OR/HR001	335mm long

Charnley Prosthesis Pusher

Stainless steel handle with nylon insert



Code	Description
SC-OR/N021	180mm long

Moore Femoral Head Extractor

With T handle

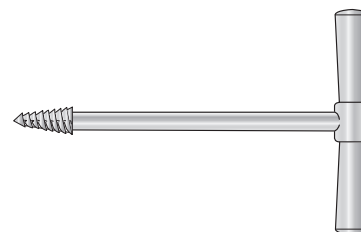

Code	Description
SC-OR/N005	150mm long
SC-OR/N006	205mm long

Judet Impactor

Stainless steel handle with nylon head

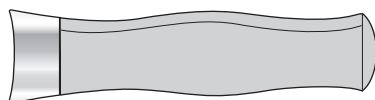

Code	Description
SC-OR/N009	140mm long

Murphy Skids

Double ended, 355mm long



Code	Description
SC-OR/N007	Uncoated
SC-DIA/111	Coated

Femoral Pusher

Head impactor, white Pomalux

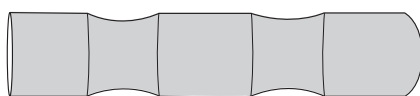

Code	Description
SC-OR/N053	31mm ø x 180mm long

Murphy Skids

Single ended, 330mm long



Code	Description
SC-OR/N007a	Coated

Adson Periosteal Elevator

Serrated grip, 165mm long

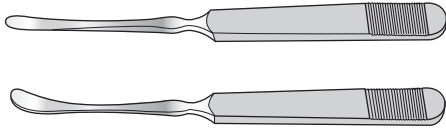

straight

Code	Description
SC-OR/N028	7mm wide

curved

Code	Description
SC-OR/N029	5mm wide
SC-OR/N030	7mm wide

Langenbeck Elevator

Straight

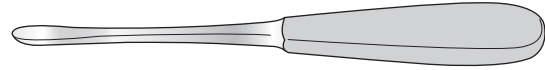

Code	Description
SC-OR/302	200mm long

Bristow Periosteal Elevator

Sharp edge



Code	Description
SC-OR/N010	240mm long

MacDonald Dissector Double Ended



Code	Description
SC-GI/285	191mm long

Doyen Periosteal Elevator

Satin finish handle

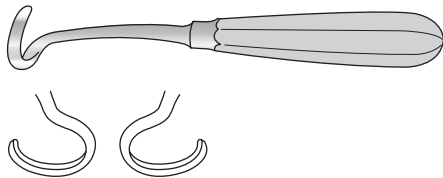

165mm long

Code	Description
SC-OR/N031	Right
SC-OR/N032	Left

180mm long

Code	Description
SC-OR/256	Right
SC-OR/255	Left

Pennybacker Elevator

Curved, sharp, 6mm wide

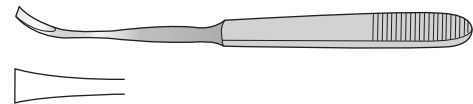

Code	Description
SC-OR/N025	170mm long

Key Periosteal Elevator

190mm long

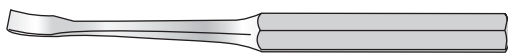

Code	Description
SC-OR/N023	10mm wide
SC-OR/N024	13mm wide

Periosteal Elevator

Straight



Code	Description
SC-OR/19a	175mm long

Elevators

Periosteal Elevator

Straight, 12 x 20mm, with blue acetal "Suregrip" handle



Code	Description
SC-OR/SH-5695	195mm long

Periosteal Elevator

Curved, 5 x 25mm, with blue acetal "Suregrip" handle



Code	Description
SC-OR/SH-5696	185mm long

Tudor Edwards Periosteal Elevator

For first rib, satin finish handle, 175mm long

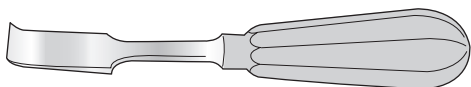

Code	Description
SC-OR/N026	12mm wide
SC-OR/N027	18mm wide

Hohmann Bone Elevator

Matt finish, 160mm long

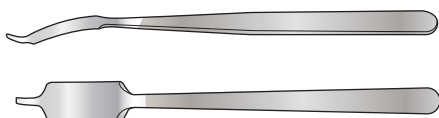

Code	Description
SC-OR/307a	6mm wide
SC-OR/307b	8mm wide
SC-OR/307d	10mm wide
SC-OR/307e	15mm wide

Hohmann-Muller Spike Elevator

With narrow spade



Code	Description
SC-OR/307f	220mm long, 10mm wide
SC-OR/307	230mm long, 12mm wide
SC-OR/308	240mm long, 18mm wide

Hohmann-Aldinger Bone Elevator

Curved

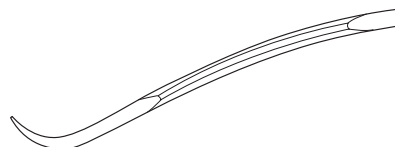

Code	Description
SC-OR/304	270mm long x 24mm wide

Hohmann Bone Elevator

Curved

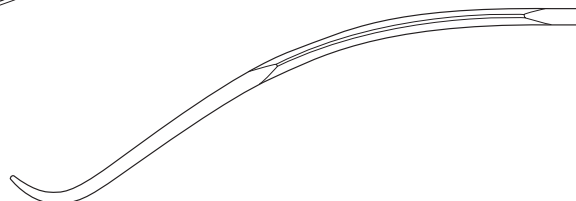

Code	Description
SC-OR/305	285mm long x 34mm wide

Hohmann Bone Lever

Curved, Leicester Royal Infirmary pattern

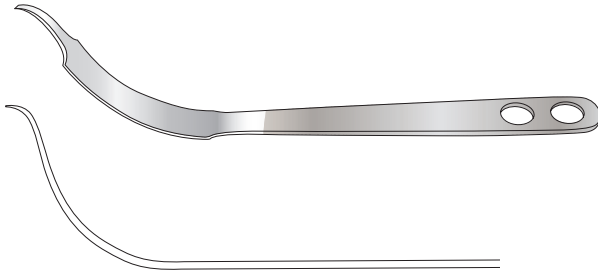

Code	Description
SC-OR/LGH-HOH	340mm long x 23mm wide

Wagner Bone Elevator

220mm long

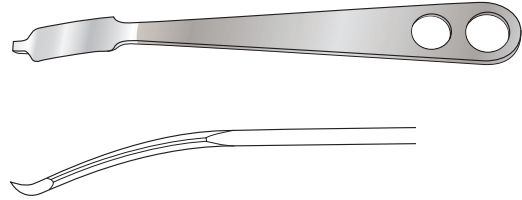

Code	Description
SC-OR/307h	17mm wide

Schumacher Bone Elevator

290mm long

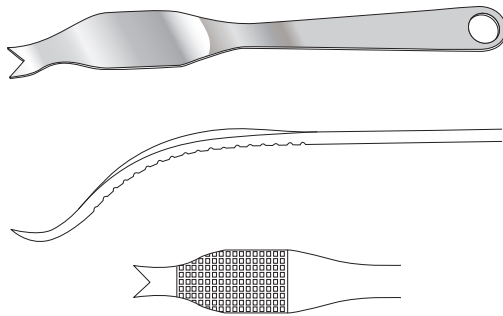

Code	Description
SC-OR/307k	35mm wide, 18mm at edge

Lange-Hohmann Bone Elevator

250mm long

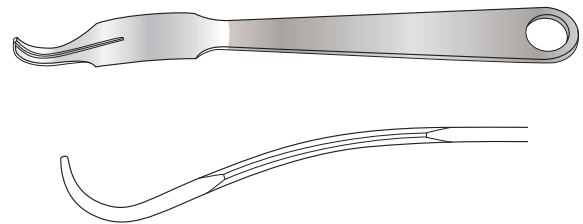

Code	Description
SC-OR/307i	24mm wide

Muller Soft Tissue Retractor

40mm wide

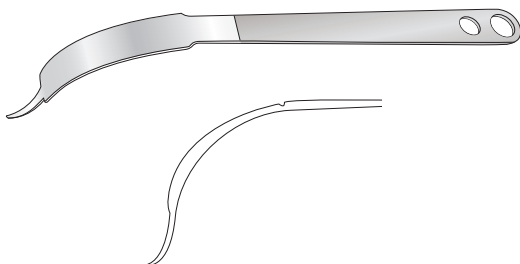

Code	Description
SC-OR/307aNOR	410mm long
SC-OR/307bNOR	300mm long

Schumacher Bone Elevator

345mm long

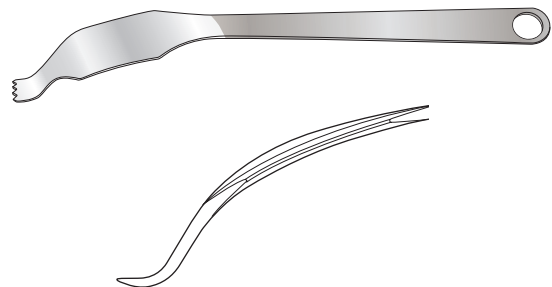

Code	Description
SC-OR/307j	37mm wide, 18mm at edge

Retractors and Bone Levers

Fakuda Type Retractor

230mm long

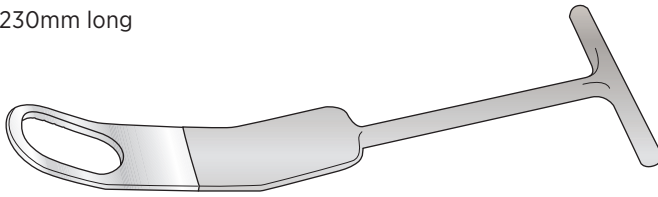

Code

SC-OR/SH5507

Hohmann Retractor

45° angle, 200mm long

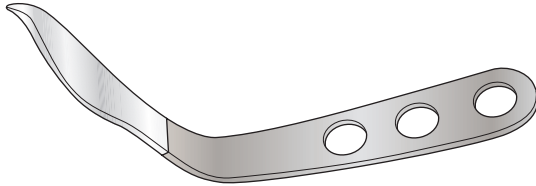

Code

SC-OR/SH5394

Hohmann Tapered Spike Retractor

225mm overall length

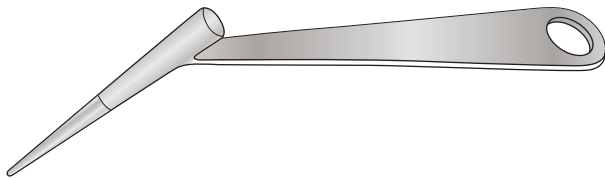

Code

SC-OR/308a

Posterior Bone Lever

230mm long



Code

SC-OR/308r

Trethowan Bone Lever

Bent, ring handle 222mm long, 280mm long

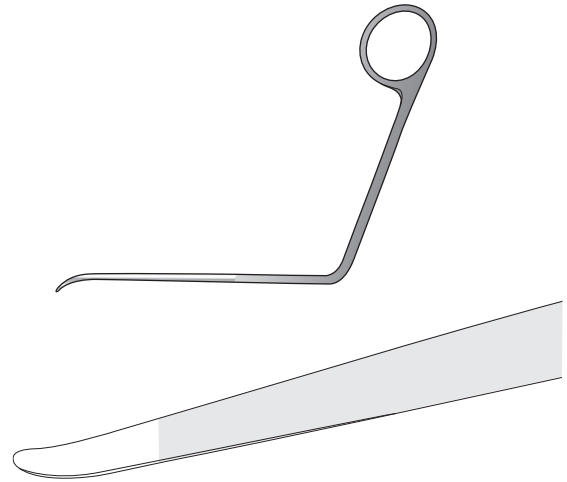

Code	Description
SC-OR/no17b	90° angle
SC-OR/no17c	70° angle (illustrated)
SC-OR/no17d	45° angle

Saws, Shears and Knives

Gigli Saw Handles

Per pair

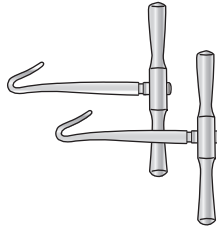

Code	Description
SC-OR/08	65mm long

Guys Tenotomy Knife



Code	Description
SC-OR/N046	140mm long

Charnley Saws

Code	Description
SC-OR/10c	500mm long
SC-OR/11c	700mm long

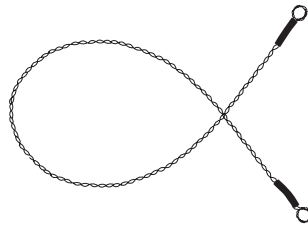

Smillie Menisectomy Knife

175mm long



Code	Description
SC-OR/048	Straight

Gigli Saws

Code	Description
SC-OR/09	300mm long
SC-OR/10	500mm long
SC-OR/11	700mm long

Smillie Menisectomy Knife

Protruding beak at base, 175mm long

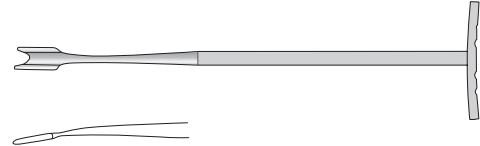

Code	Description
SC-OR/N0048a	Curved to right
SC-OR/N0048b	Curved to left

Collin Rib Shears

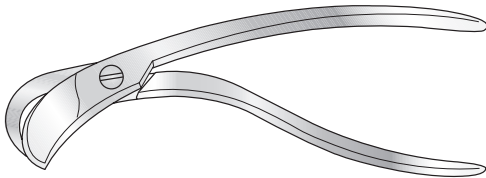

Code	Description
SC-OR/001	195mm long

Screw and Plate Instruments

Allen Key Sets

Bright guard

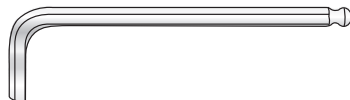

Code	Description
SC-OR/N051	1.5mm - 10mm

To order quote SC-OR/N051 then add size required e.g. SC-OR/N051-1.5

Size mm	Overall Length
1.5	63mm
2.0	77mm
2.5	87mm
3.0	93mm
4.0	104mm
5.0	120mm
6.0	141mm
7.0	147mm
8.0	158mm
10.0	180mm

Orthopaedic Ruler Stainless Steel



Code	Description
SC-OR/51a	Metric, 300mm

Pins

Denham Pin

Temporary implants, material conforms to BS 7252: Part 1: 1997. ISO 5832-1: 1997. Comp.D. CE marking available on request.



Code	Size
SC-DP/1-3SE	3.96mm dia x 203mm long trocar/3 side end
SC-DP/1SQ	3.96mm dia x 203mm long trocar/square end
SC-DP/2-3SE	3.96mm dia x 229mm long trocar/3 side end
SC-DP/2SQ	3.96mm dia x 229mm long trocar/square end

Code	Size
SC-DP/3-3SE	4.76mm dia x 203mm long trocar/3 side end
SC-DP/3SQ	4.76mm dia x 203mm long trocar/square end
SC-DP/4-3SE	4.76mm dia x 229mm long trocar/3 side end
SC-DP/4SQ	4.76mm dia x 229mm long trocar/square end

THREE SIDED END OR
 SQUARE END IN STOCK
 OTHER SIZES AVAILABLE

Steinmann Pins

Temporary implants, material conforms to BS 7252: Part 1: 1997. ISO 5832-1: 1997. Comp.D. CE marking available on request

Various specs available -
 contact us for full information

Ø mm*	Ø mm*
1.58	3.96
2.00	4.36
2.38	4.76
2.78	6.00
3.17	6.35
3.57	8.00

LENGTHS 150, 180, 200, 250mm
 *Other lengths and diameters available

When ordering, use prefix letters
 with size following
 e.g. Trocar with one screw end
 Ø4.76mm = IPTS/476



IPTT = trocar/trocar ends



IPTS = trocar/trocar with one screw end



IPTSE = trocar/square end



IPTSE3 = trocar/with 3 sided end

Bohler Stirrup

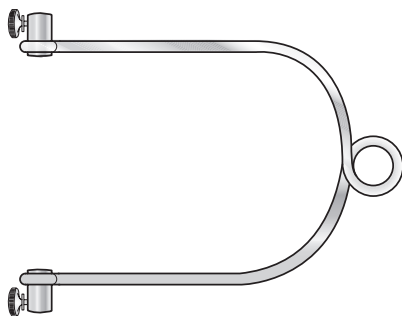

Code	Description
SC-OR/N001	Small 89 x 102mm
SC-OR/N002	Medium 114 x 165mm
SC-OR/N003	Large 152 x 241mm

Steinmann Pin Cap with Screw

Code	Description
SC-OR/54b-4	4mm ø
SC-OR/54c	Replacement screw

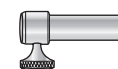

SC-OR 54b

Sterile Kirschner and Arthrodesis Wires

Temporary implants, material conforms to BS 7252: Part 1: 1997. ISO 5832-1: 1997. Comp.D.

Sterile Trocar/ Sterile Trocar Arthrodesis Wires

Code	Size
KWHS325A-S	0.8mm x 70mm
KWHS037-S	0.9mm x 70mm
KWHS055-S	0.9mm x 75mm
KWHS091-S	0.9mm x 100mm
KWHS127-S	0.9mm x 125mm
KWHS145-S	0.9mm x 140mm
KWHS0009-S	0.9mm x 150mm
KWHS163-S	0.9mm x 180mm
KWHS038-S	1.0mm x 70mm
KWHS056-S	1.0mm x 75mm
KWHS092-S	1.0mm x 100mm
KWHS269-S	1.1mm x 90mm
KWHS272-S	1.1mm x 100mm
KWHS275-S	1.1mm x 115mm
KWHS278-S	1.1mm x 125mm
KWHS281-S	1.1mm x 140mm
KWHS0010C-S	1.1mm x 150mm

Code	Size
KWHS290-S	1.1mm x 200mm
KWHS0019B-S	1.25mm x 150mm
KWHS039-S	1.2mm x 70mm
KWHS093-S	1.2mm x 100mm
KWHS129-S	1.2mm x 125mm
KWHS147-S	1.2mm x 140mm
KWHS0010B-S	1.2mm x 150mm
KWHS165-S	1.2mm x 180mm
KWHS183-S	1.2mm x 200mm
KWHS040-S	1.4mm x 70mm
KWHS094-S	1.4mm x 100mm
KWHS112-S	1.4mm x 115mm
KWHS130-S	1.4mm x 125mm
KWHS148-S	1.4mm x 140mm
KWHS0011-S	1.4mm x 150mm
KWHS166-S	1.4mm x 180mm
KWHS184-S	1.4mm x 200mm

Code	Size
KWHS005-S	1.6mm x 50mm
KWHS041-S	1.6mm x 70mm
KWHS095-S	1.6mm x 100mm
KWHS113-S	1.6mm x 115mm
KWHS131-S	1.6mm x 125mm
KWHS0012-S	1.6mm x 150mm
KWHS167-S	1.6mm x 180mm
KWHS185-S	1.6mm x 200mm
KWHS283-S	1.8mm x 200mm
KWHS096-S	2.0mm x 100mm
KWHS114-S	2.0mm x 115mm
KWHS132-S	2.0mm x 125mm
KWHS0013-S	2.0mm x 150mm
KWHS168-S	2.0mm x 180mm
KWHS186-S	2.0mm x 200mm

Sterile Trocar/Sterile Kirschner Wires (Pack of 10 Sterile Singles)

Code	Size
KWHS325-S	0.8mm x 70mm
KWHS043-S	0.9mm x 70mm
KWHS091-S	0.9mm x 100mm
KWHS097-S	0.9mm x 100mm
KWHS133-S	0.9mm x 125mm
KWHS151-S	0.9mm x 140mm
KWHS0014A-S	0.9mm x 150mm
KWHS169-S	0.9mm x 180mm
KWHS044-S	1.0mm x 70mm
KWHS062-S	1.0mm x 75mm
KWHS098-S	1.0mm x 100mm
KWHS270-S	1.1mm x 90mm
KWHS273-S	1.1mm x 100mm
KWHS276B-S	1.1mm x 115mm
KWHS279-S	1.1mm x 125mm
KWHS282-S	1.1mm x 140mm
KWHS285-S	1.1mm x 150mm

Code	Size
KWHS291-S	1.1mm x 200mm
KWHS0015A-S	1.25mm x 150mm
KWHS045-S	1.2mm x 70mm
KWHS099-S	1.2mm x 100mm
KWHS135-S	1.2mm x 125mm
KWHS153-S	1.2mm x 140mm
KWHS0019-S	1.2mm x 150mm
KWHS171-S	1.2mm x 180mm
KWHS189-S	1.2mm x 200mm
KWHS046-S	1.4mm x 70mm
KWHS100-S	1.4mm x 100mm
KWHS118-S	1.4mm x 115mm
KWHS136-S	1.4mm x 125mm
KWHS154-S	1.4mm x 140mm
KWHS0021-S	1.4mm x 150mm
KWHS172-S	1.4mm x 180mm
KWHS190-S	1.4mm x 200mm

Code	Size
KWHS011-S	1.6mm x 50mm
KWHS047-S	1.6mm x 70mm
KWHS101-S	1.6mm x 100mm
KWHS119-S	1.6mm x 115mm
KWHS137-S	1.6mm x 125mm
KWHS0017-S	1.6mm x 150mm
KWHS173-S	1.6mm x 180mm
KWHS191-S	1.6mm x 200mm
KWHS475-S	1.8mm x 200mm
KWHS102-S	2.0mm x 100mm
KWHS120-S	2.0mm x 115mm
KWHS138-S	2.0mm x 125mm
KWHS0018-S	2.0mm x 150mm
KWHS174-S	2.0mm x 180mm
KWHS192-S	2.0mm x 200mm

OTHER SIZES, FULL AND PARTIALLY THREADED STYLES ARE ALSO AVAILABLE PLEASE CONTACT US WITH YOUR REQUIREMENTS.

Extremities Instruments and Sets

Fine Hand Set

Includes: small stille type mallet 17cm long and 2mm, 4mm, 6mm, 8mm, 10mm and 12mm osteotomes

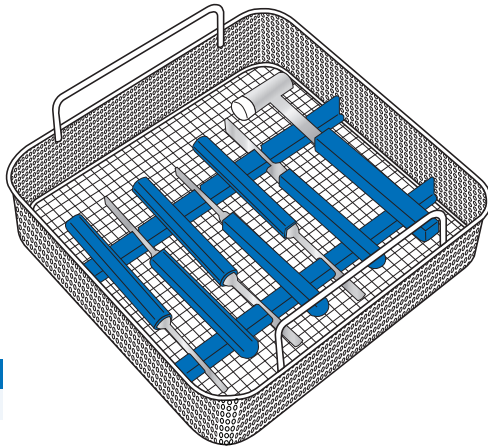

Code
SH-6969

Mini-Lexer Gouges

With blue acetal handle



Code	Description
SC-OR/587-04	4mm wide, 18cm long
SC-OR/587-06	6mm wide, 18cm long
SC-OR/587-08	8mm wide, 18cm long
SC-OR/587-10	10mm wide, 18cm long

Flexible Chisels and Blades

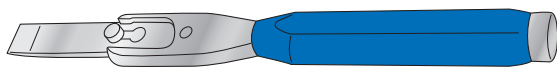

Code	Description
SC-OR/593	Allen key for flat chisel blades introducer handle 185mm long
SC-OR/594	Chisel blade 5mm for introducer handle
SC-OR/594A	Chisel blade 5mm curved for introducer handle
SC-OR/595	Chisel blade 10mm for introducer handle
SC-OR/595A	Chisel blade 10mm curved for introducer handle
SC-OR/596	Chisel blade 15mm for introducer handle
SC-OR/596A	Chisel blade 15mm curved for introducer handle
SH-6954	Introducer handle for flat chisel blades 185mm long

Mini-Lexer Osteotome and Gouge Set

Includes 4mm, 6mm, 8mm, 10mm gouges 18cm long and 2mm, 4mm, 6mm, 8mm and 10mm osteotomes 18cm long

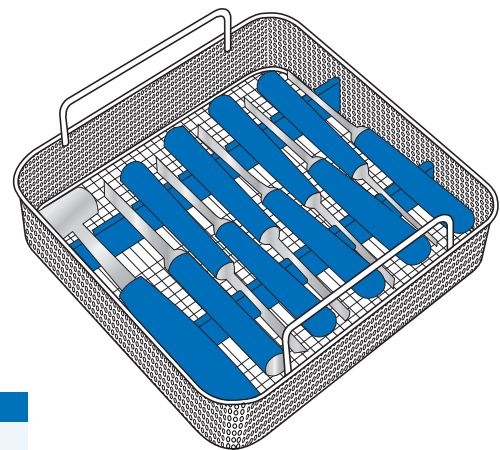

Code
SC-OR/587

Mini Fine Hand Osteotomes

With blue acetal handle



Code	Description
SH-6956	2mm wide, 165mm long
SH-6957	4mm wide, 165mm long
SH-6958	6mm wide, 165mm long
SH-6959	8mm wide, 165mm long
SH-6960	10mm wide, 165mm long
SH-6961	12mm wide, 165mm long

Mini-Lexer Osteotomes

With blue acetal handle



Code	Description
SC-OR/588-02	2mm wide, 18cm long
SC-OR/588-04	4mm wide, 18cm long
SC-OR/588-06	6mm wide, 18cm long
SC-OR/588-08	8mm wide, 18cm long
SC-OR/588-10	10mm wide, 18cm long

Removable Flexible Chisel and Blade Set

With blue acetal handle

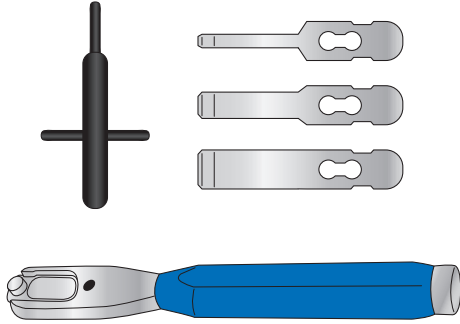

Code	Description
SH-7002	5mm, 10mm and 16mm straight
SH-7002A	5mm, 10mm and 16mm curved

Chirobloc Hand Immobiliser

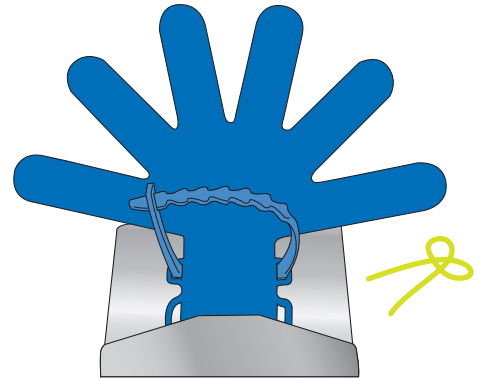

Code	Description
CB3	Chirobloc 3 with wrist strap and 5 ForgetMeNots
CBL	Chirobloc Ballast
CBM	Chirobloc Large
CBP	Chirobloc Small
FMN2B.B	Chirobloc ForgetMeNot Blue
FMN2B.Y	Chirobloc ForgetMeNot Yellow

Small Mallet

Small mallet 340 gram 210mm long with one flat and one round end fitted with blue acetal handle

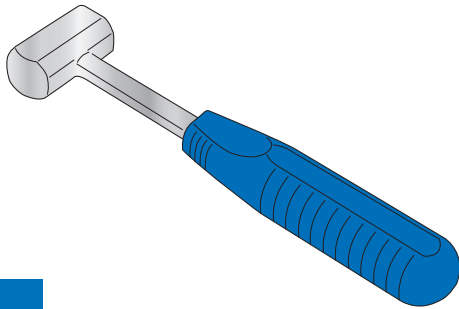

Code
SH-6955

Small Stille Type Mallet

Ultra fine mallet 180mm long with one nylon head fitted with a blue acetal handle 180 gram

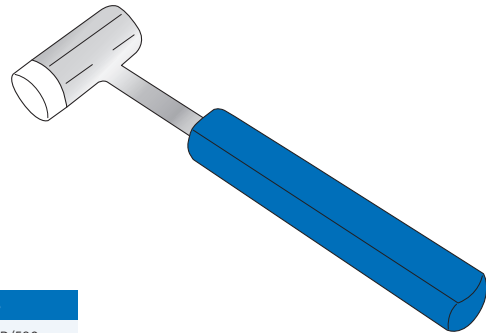

Code
SC-OR/580

Shoulder Instruments

Kolbel Soft Tissue Retractor

Single-pronged, angled, 190mm

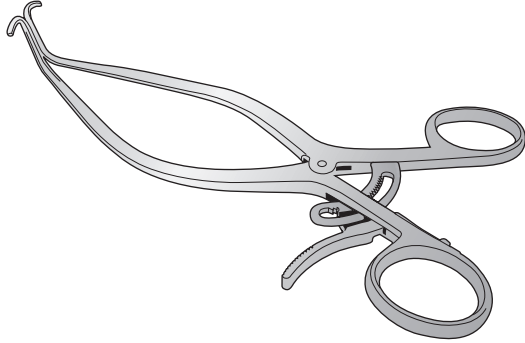

Code

SH004637943

Kolbel Soft Tissue Retractor

Single-pronged, straight, very fine tips, 190mm

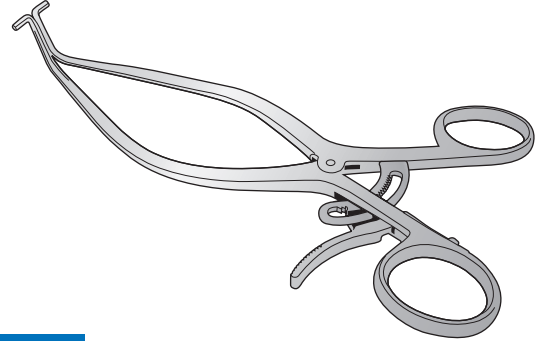

Code

SH004636943

Kolbel Soft Tissue Retractor

Double pronged, angled, 190mm

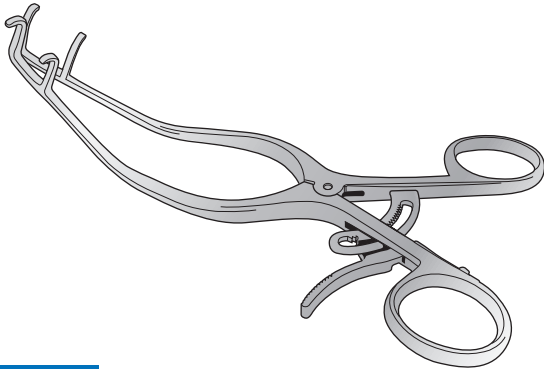

Code

SH004454965

Capsule Spreader

Single-pronged, fine, 90° curved, 165mm

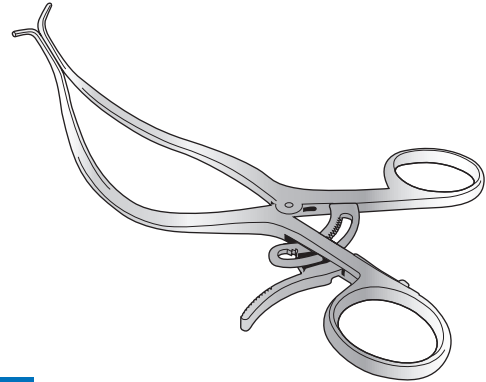

Code

SH004455954

Fukuda-Kujat Humeral Head Retractor

35mm, wide blade, 225mm

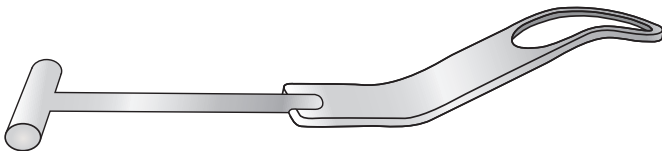

Code

SH0046351113

Kolbel Self Retaining Glenoid Retractor

With ball snap-fit, slightly curved, 200mm

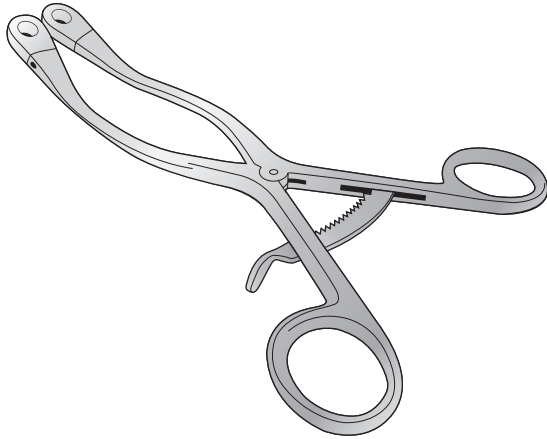

Code
SH004459965

Kolbel Glenoid Retractor

Double-pronged, angled tips, 300mm, 18mm straight



Code
SH004458416

Kolbel Glenoid Retractor

Double-pronged, angled tips, 300mm, 15mm strongly curved



Code
SH004457V318416

Pair of Kolbel Self Retaining Glenoid Retractor Blades

With ball fit

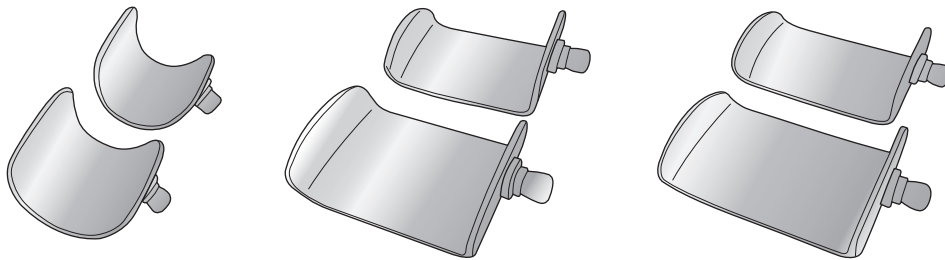

Code	Description
SH004460954	Pair of blades size 36 x 36mm
SH004461V316	Pair of blades size 53 x 36mm
SH004462V319	Pair of blades size 68 x 36mm