

Retractors



**ARTIFIED**  
INTERNATIONAL



**A-SI-4240**  
1/1  
16 cm / 6 1/4"

**A-SI-4241 flexible**  
1/1

**A-SI-4242 sharp**  
1/1

**A-SI-4243 sharp**  
1/1  
16 cm / 6 1/4"

**A-SI-4244 blunt**  
1/1  
16 cm / 6 1/4"

**A-SI-4245 blunt**  
1/1

**A-SI-4246 blunt**  
1/1

**A-SI-4247 blunt**  
1/1  
16 cm / 6 1/4"

**MOLDESTAD A-SI-4248**  
1/2  
12 cm / 4 3/4"

**CUSHING-KOCHER A-SI-4259**  
1/2  
16 cm / 6 1/4"

**DESMARRES A-SI-4254**  
1/1  
10 x 10 mm

**A-SI-4249**  
1/1  
8 mm

**A-SI-4250**  
1/1  
10 mm

**A-SI-4251**  
1/1  
12 mm

**A-SI-4252**  
1/1  
12 mm

**A-SI-4253**  
1/1  
14 mm

**A-SI-4254**  
1/1  
14 mm

**A-SI-4255**  
1/1  
16 mm

**A-SI-4256**  
1/1  
18 mm

**A-SI-4257**  
1/1  
16 mm

**A-SI-4258**  
1/1  
18 mm

16 cm / 6 1/4"



**MINI-LANGENBECK**  
16 cm / 6 1/4"



**A-SI-4260**  
10 x 6 mm

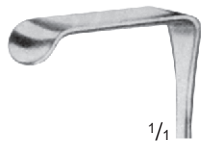

**A-SI-4261**  
17 x 5 mm



**A-SI-4262**  
20 x 6 mm



**A-SI-4263**  
22 x 8 mm



**LANGENBECK-GREEN**  
16 cm / 6 1/4"



**A-SI-4264**

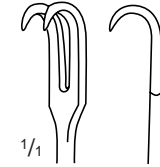

**A-SI-4266**

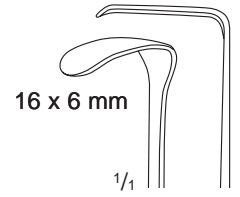

16 x 6 mm

**A-SI-4265**

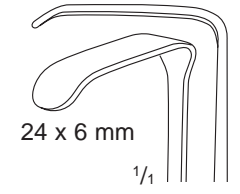

24 x 6 mm

**A-SI-4267**

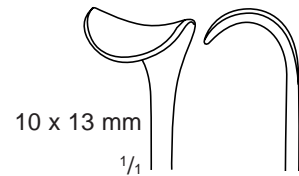

10 x 13 mm

**A-SI-4268**

14 x 8 mm



**A-SI-4274**  
16 cm / 6 1/4"



16 cm / 6 1/4"



**A-SI-4269**



**A-SI-4270**



**A-SI-4271**



**A-SI-4273**



1/1  
sharp



16 cm / 6 1/4"



**A-SI-4275**



**A-SI-4276**



**A-SI-4277**



**A-SI-4278**



1/1  
blunt



16 cm / 6 1/4"



**A-SI-4279**



**A-SI-4280**



**A-SI-4281**



**A-SI-4282**



1/1  
semi-sharp

Retractors



**ARTIFED**  
INTERNATIONAL

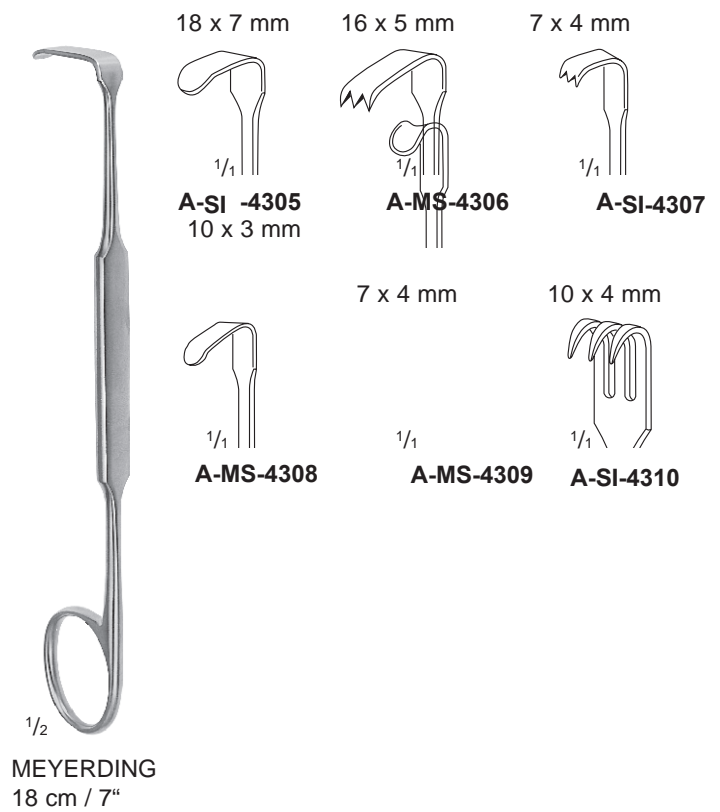
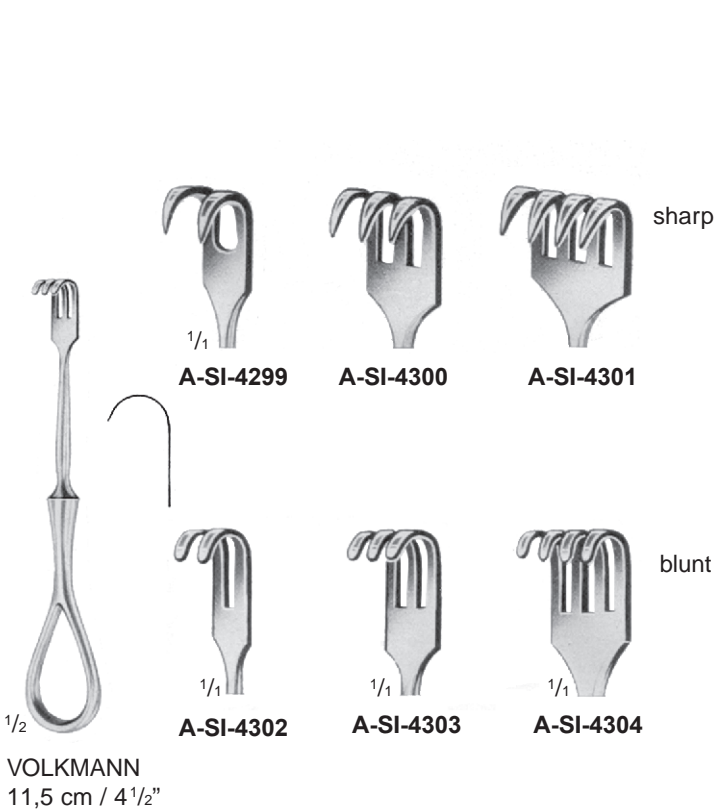
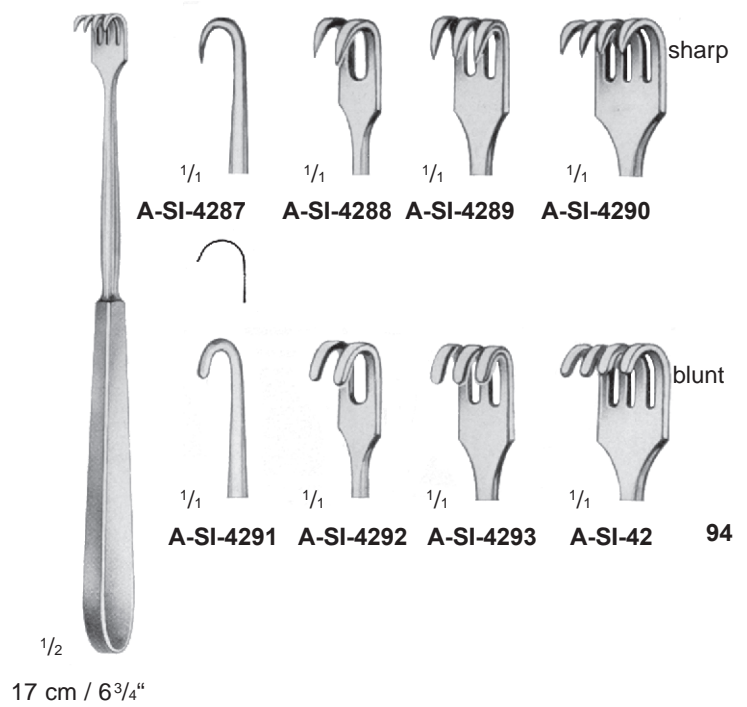
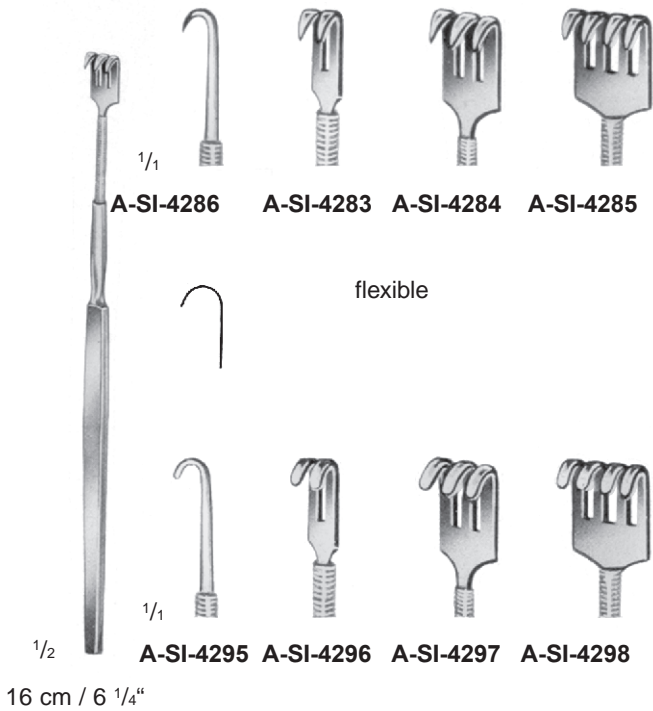



**A-SI-4311**  
20 x 6 mm

**A-SI-4312**  
10 x 6 mm

**SENN-GREEN**  
15 cm / 6"

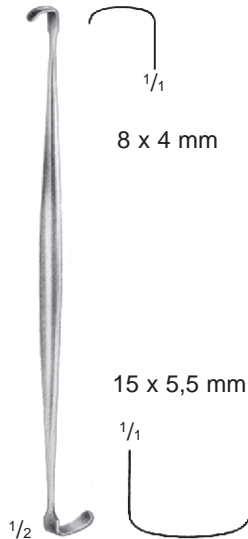

8 x 4 mm

15 x 5,5 mm

**RAGNELL-DAVIS**  
**A-SI-4315**  
14 cm / 5 1/2"

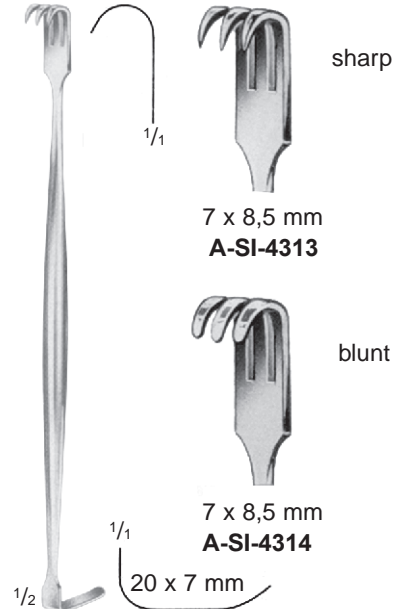

sharp

7 x 8,5 mm  
**A-SI-4313**

blunt

7 x 8,5 mm  
**A-SI-4314**

**SENN-MILLER**  
16 cm / 6 1/4"

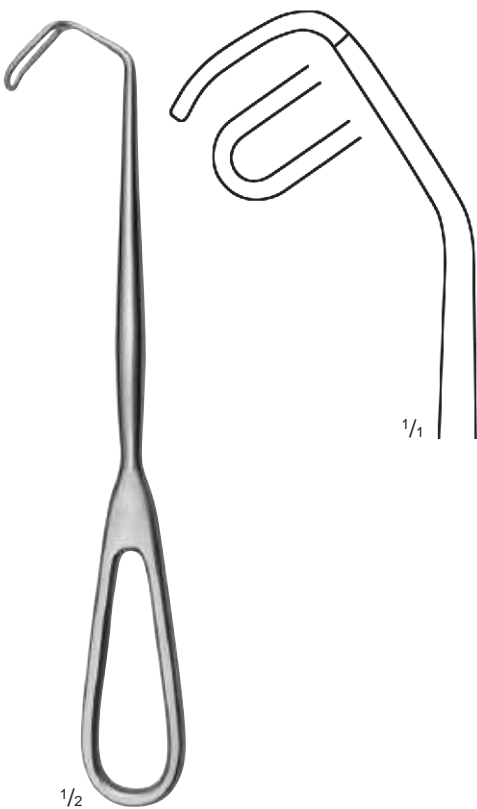

**CUSHING**  
**A-SI-4321**  
20,5 cm / 8"

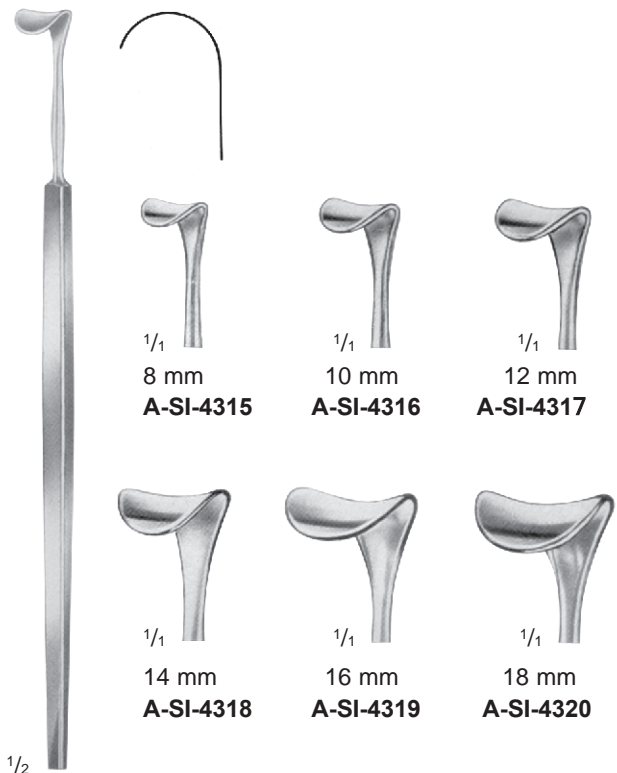

1/1  
8 mm  
**A-SI-4315**

1/1  
10 mm  
**A-SI-4316**

1/1  
12 mm  
**A-SI-4317**

1/1  
14 mm  
**A-SI-4318**

1/1  
16 mm  
**A-SI-4319**

1/1  
18 mm  
**A-SI-4320**

**CUSHING**  
20 cm / 8"

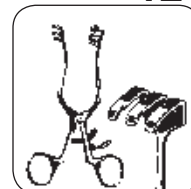

CUSHING  
24 cm / 9 1/2"

1/2



1/1  
8 mm  
A-SI-422



1/1  
10 mm  
A-SI-4323



1/1  
12 mm  
A-SI-4323



1/1  
14 mm  
A-SI-4324



1/1  
16 mm  
A-SI-4325



1/1  
18 mm  
A-SI-4326



KÖNIG  
17 cm / 6 3/4"

1/2



1/1  
13 x 13 mm  
A-SI-4327



1/1  
13 x 16 mm  
A-SI-4330



KLAPP  
17,5 cm / 7"

1/2



1/1  
A-SI-4327



1/1  
A-SI-4328



1/1  
A-SI-4329



**STRANDELL-STILLE**  
19 cm / 7 1/2"



1/1  
**A-SI-4331**



1/1  
**A-SI-4332**  
toothed

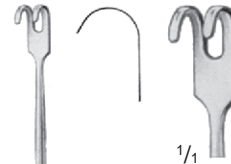

1/1

1/2

**A-SI-4333**  
13,5 cm / 5 1/4"

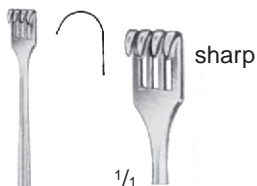

sharp

1/1  
**A-SI-4336**

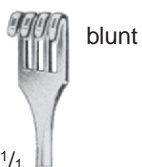

blunt

1/1  
**A-SI-4340**

1/2  
16 cm / 6 1/4"



1/2



1/1

1/2  
**A-SI-4337**



1/2

**A-SI-4334**



1/2

**A-SI-4338**



1/2

**A-SI-4335**



1/2

**A-SI-4339**

sharp



1/1

**A-SI-4343**  
VOLKMANN  
23 cm / 9"



1/2

**A-SI-4341**



1/2

**A-SI-4342**

blunt



1/2



1/2

**A-SI-4344**

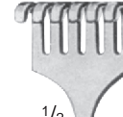

1/2

**A-SI-4345**



















Retractors

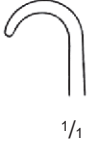

**ARTIFIED**  
INTERNATIONAL



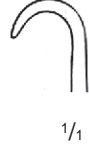

1/2

|   |   |   |   |   |   |   |
|---|---|---|---|---|---|---|
| <br>1/2<br><b>A-SI-4346</b>  | <br>1/2<br><b>A-SI-4347</b>  | <br>1/2<br><b>A-SI-4348</b>  | <br>1/2<br><b>A-SI-4349</b>  | <br>1/2<br><b>A-SI-4350</b>  | <br>1/2<br><b>A-SI-4351</b>  | <br>1/4<br>sharp       |
| <br>1/2<br><b>A-SI-4352</b>  | <br>1/2<br><b>A-SI-4353</b>  | <br>1/2<br><b>AMS-4354</b>   | <br>1/2<br><b>A-SI-4355</b>  | <br>1/2<br><b>A-SI-4356</b>  | <br>1/2<br><b>A-SI-4357</b>  | <br>1/4<br>blunt       |
| <br>1/2<br><b>A-SI-4358</b> | <br>1/2<br><b>A-SI-4359</b> | <br>1/2<br><b>A-SI-4360</b> | <br>1/2<br><b>A-SI-4361</b> | <br>1/2<br><b>A-SI-4362</b> | <br>1/2<br><b>A-SI-4363</b> | <br>1/4<br>semi-sharp |

**VOLKMANN**  
21,5 cm / 8 1/2"

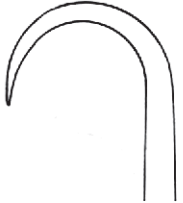
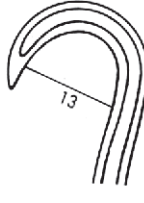
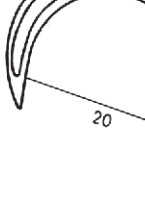

1/2

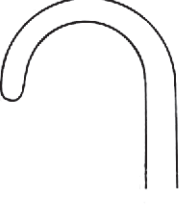
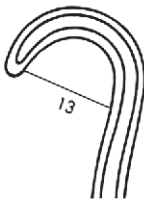
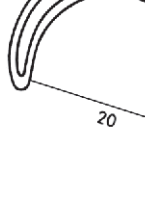
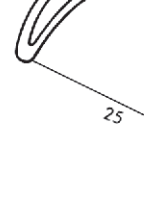
|  |   |  |   |
|--|---|--|---|
| <br><b>VOLKMANN</b><br><b>A-SI-4351</b><br>21,5 cm / 8 1/2" | <br><b>A-SI-4364</b> | <br><b>A-SI-4365</b> | <br><b>A-SI-4366</b> |
| <br><b>VOLKMANN</b><br><b>A-SI-4367</b><br>21,5 cm / 8 1/2" | <br><b>A-SI-4368</b> | <br><b>A-SI-4369</b> | <br><b>A-SI-4370</b> |

**A-SI-471 A-SI-4372**  
23 cm / 9"



1/2

**KOCHER**  
22 cm / 8<sup>3</sup>/<sub>4</sub>"

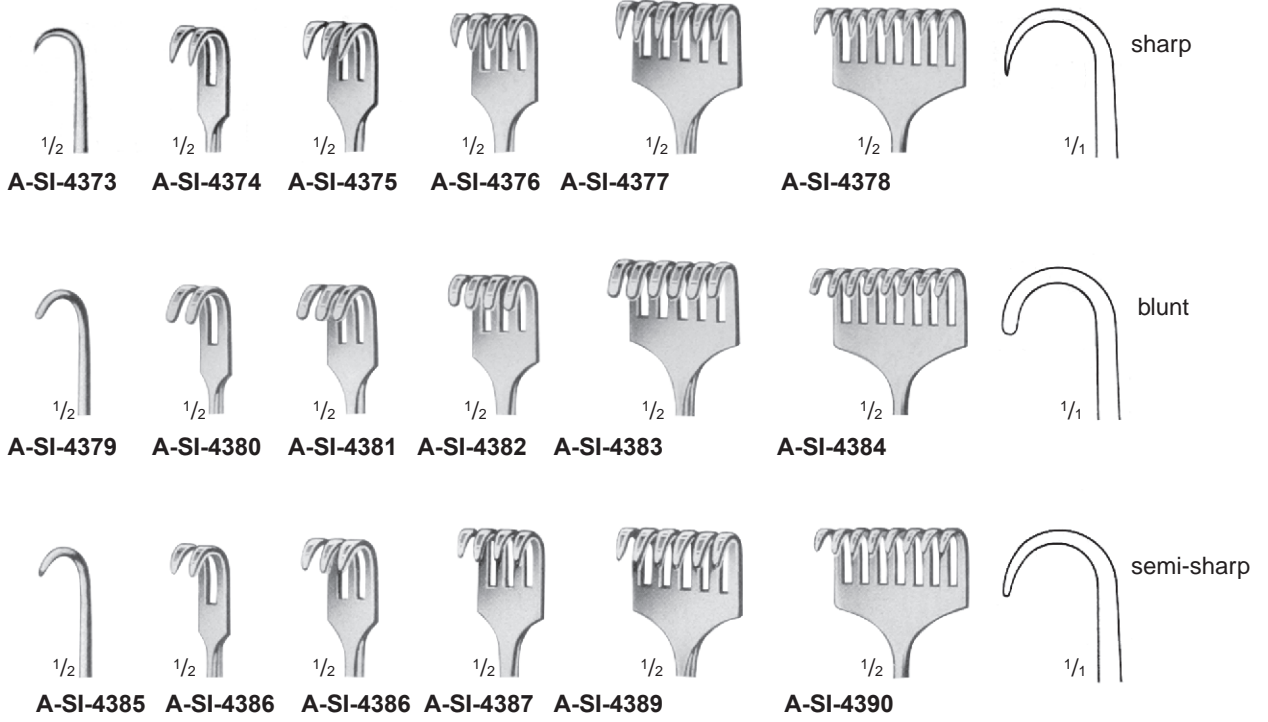

**A-SI-4391**

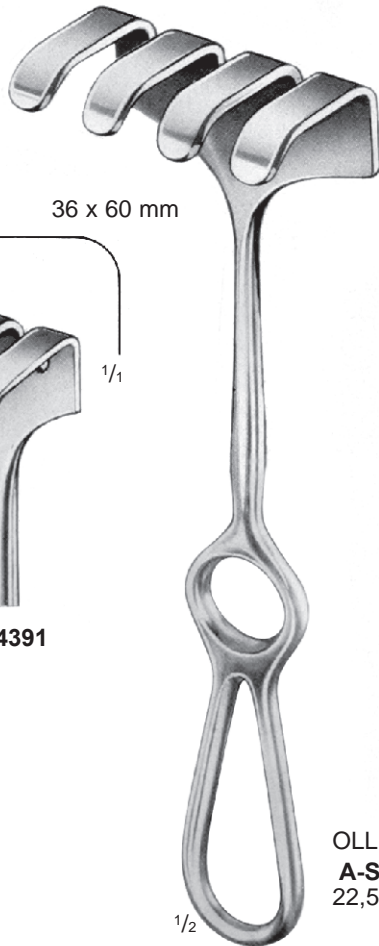

1/2

**OLLIER**  
**A-SI-4392**  
22,5 cm / 9"



1/2

**WASSMUND**  
**A-SI-4393**  
20 cm / 8"

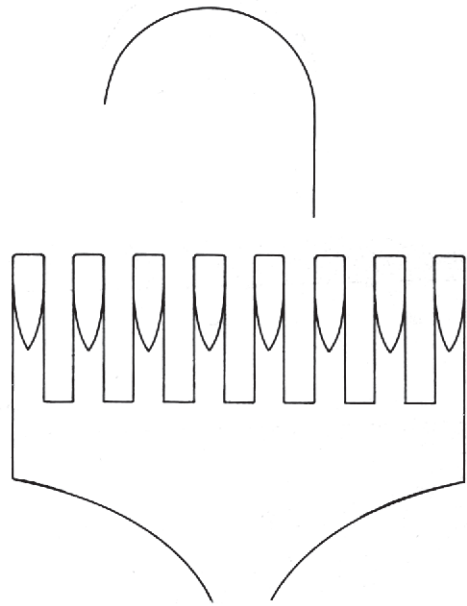
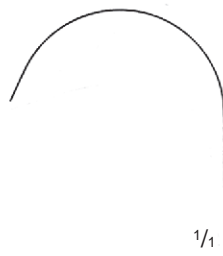
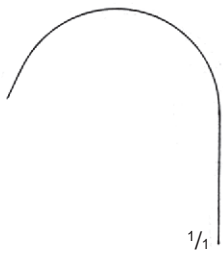

26 x 60 mm

40 x 30 mm

40 x 30 mm



1/2

**KOERTE**  
**A-SI-4394**  
23,5 cm / 9 1/4"



1/2

**KOERTE**  
**A-SI-4395**  
23,5 cm / 9 1/4"

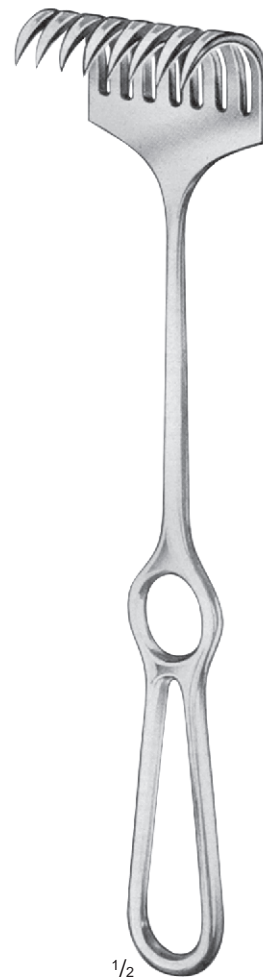

1/2

**A-SI-4396**  
25 cm / 10"

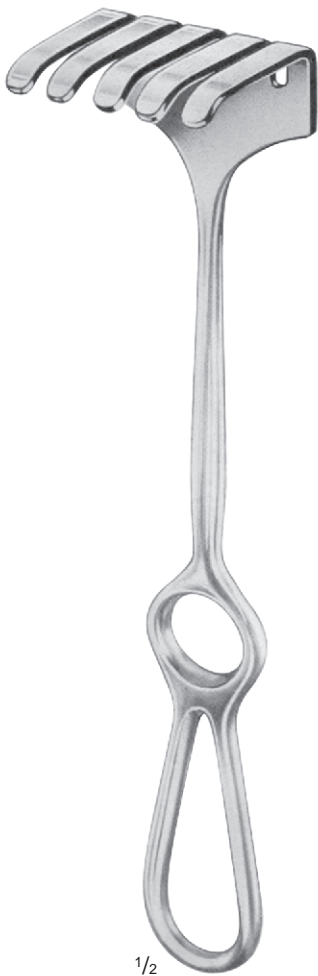
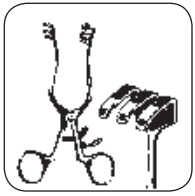

$\frac{1}{2}$   
ISRAEL  
25 cm / 10"

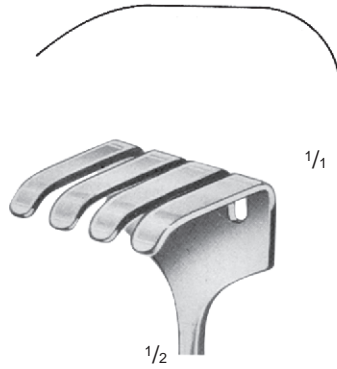

$\frac{1}{2}$   
**A-SI-4397**  
40 x 40 mm

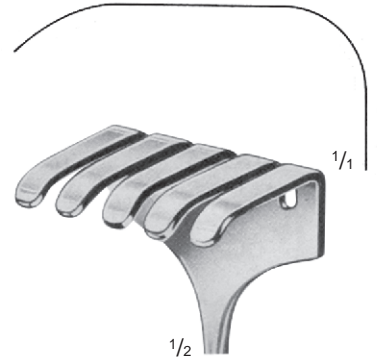

$\frac{1}{2}$   
**A-SI-4398**  
45 x 50 mm

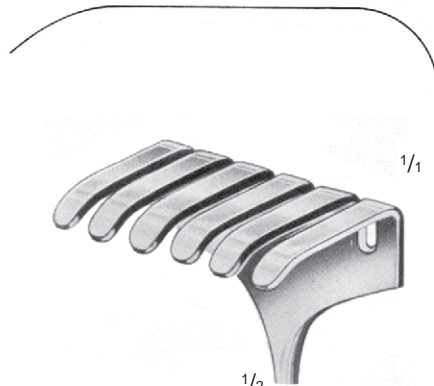

$\frac{1}{2}$   
**A-SI-4399**  
50 x 60 mm

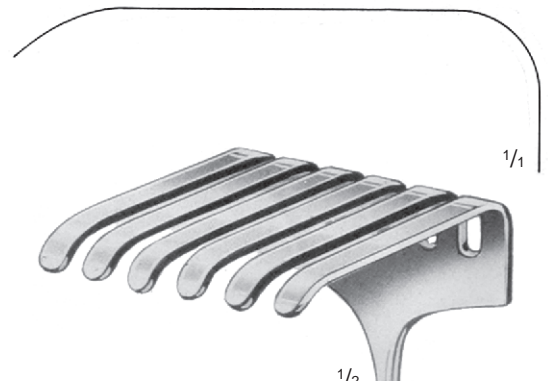

$\frac{1}{2}$   
**A-SI-4400**  
70 x 70 mm



$\frac{1}{1}$   
20 x 7 mm **A-SI-4401**

$\frac{1}{1}$   
30 x 11 mm  
**A-SI-4402**  
**A-SI-4403**

$\frac{1}{1}$   
30 x 14 mm  
**A-SI-4404**  
**A-SI-4405**

$\frac{1}{1}$   
30 x 16 mm  
**A-SI-4406**  
**A-SI-4407**

$\frac{1}{1}$   
40 x 11 mm  
**A-SI-4408**  
**A-SI-4409**

$\frac{1}{1}$   
40 x 15 mm  
**A-SI-4410**  
**A-SI-4411**

$\frac{1}{1}$   
50 x 11 mm  
**A-SI-4412**  
**A-SI-4413**



$\frac{1}{2}$   
**LANGENBECK**  
**A-SI-4418 A-SI-**  
**-4419** 22 cm /  
8 $\frac{3}{4}$ "



$\frac{1}{2}$   
**LANGENBECK**  
**A-SI-4416 A-**  
**SI-4417** 21 cm  
/ 8 $\frac{1}{2}$ "

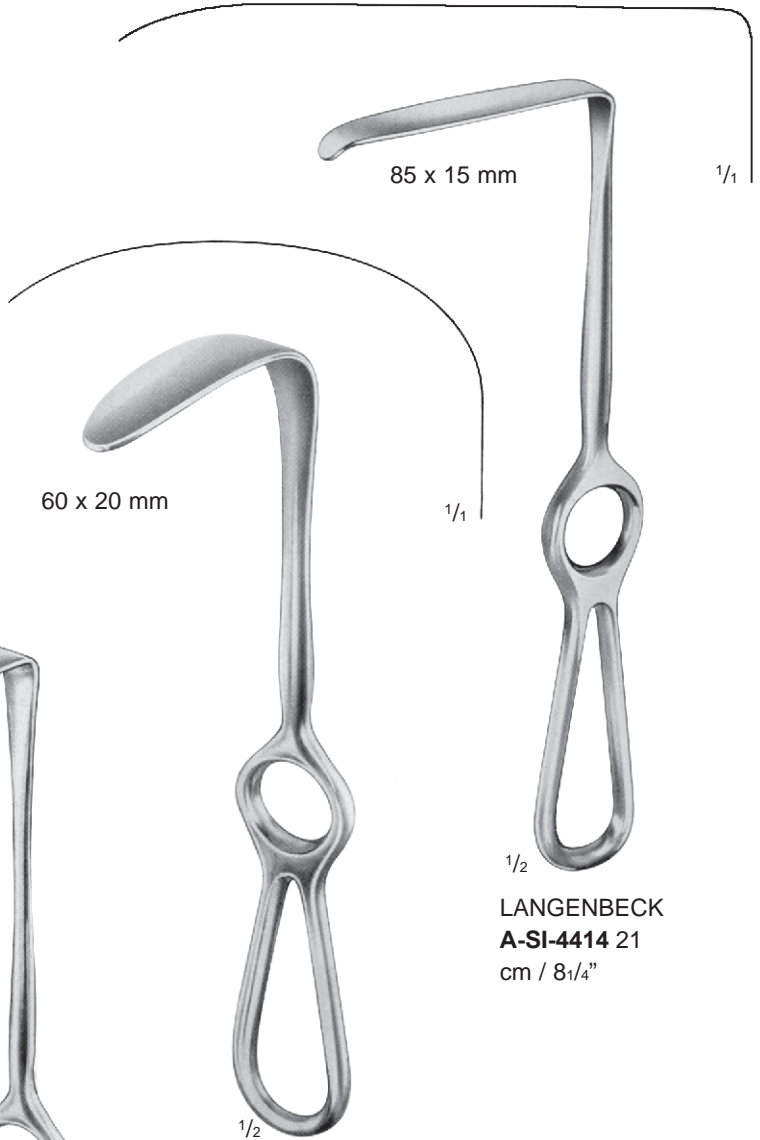

85 x 15 mm

$\frac{1}{1}$

$\frac{1}{2}$

**LANGENBECK**  
**A-SI-4414** 21  
cm / 8 $\frac{1}{4}$ "

$\frac{1}{2}$

**LANGENBECK**  
**A-SI-4415** 21  
cm / 8 $\frac{1}{4}$ "

$\frac{1}{1}$



**KOCHER A**  
-SI-4420 78  
x 40 mm 23  
cm / 9 1/4"

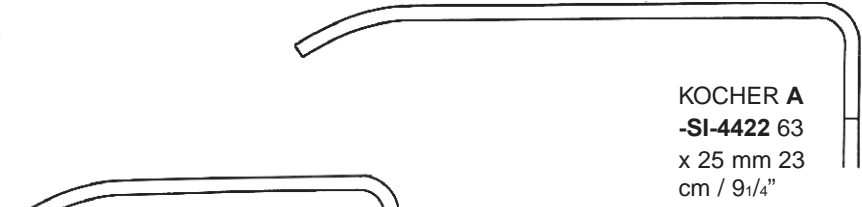

**KOCHER A**  
-SI-4422 63  
x 25 mm 23  
cm / 9 1/4"

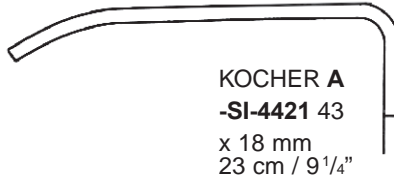

**KOCHER A**  
-SI-4421 43  
x 18 mm  
23 cm / 9 1/4"

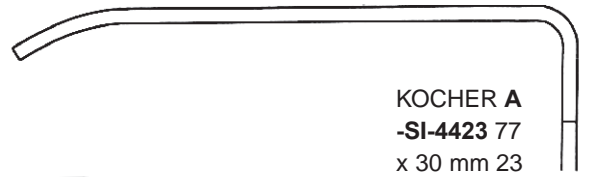

**KOCHER A**  
-SI-4423 77  
x 30 mm 23  
cm / 9 1/4"

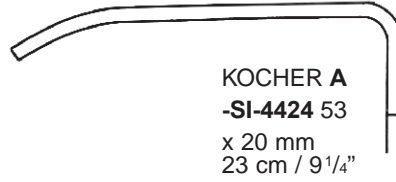

**KOCHER A**  
-SI-4424 53  
x 20 mm  
23 cm / 9 1/4"

1/2

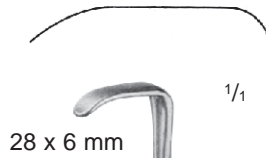

28 x 6 mm

1/2

**LAHEY A-**  
**SI-4425** 19  
cm / 7 1/2"



12 x 14 mm

1/2

**LITTLE A-SI-**  
**4426** 20 cm / 8  
"



75 x 12 mm

ZENKER  
**A-SI-4428**  
27,5 cm / 11"

35 x 8 mm

ZENKER A  
**-SI-4427**  
25 cm / 10"

85 x 20 mm

1/1

60 x 12 mm

1/1

100 x 25 mm

ZENKER A-SI-  
**4429** 28,5 cm /  
11 1/4"

ZENKER A-  
**SI-4430** 26  
cm / 10 1/2"

1/1

1/1

ZENKER A-  
**SI-4431** 30,5  
cm / 12"

35 x 8 mm

ZENKER A-  
**SI-4432** 30,  
5 cm / 12"

60 x 12 mm

ZENKER A-  
**SI-4433** 26  
cm / 10 1/2"

75 x 12 mm

ZENKER A-  
**SI-4434** 27,5  
cm / 11"

85 x 20 mm

ZENKER A-SI-  
**4435** 28,5 cm /  
11 1/4"

100 x 25 mm

ZENKER A  
**-SI-4436** 2  
30,5 cm /  
12"

ZENKER  
**A-SI-4437 A-SI-4438**



1/2  
**KOCHER**  
19 cm / 7 1/2"



1/2  
**A-SI-4439**  
19 x 12 mm



1/2  
**A-SI-4440**  
21 x 14 mm



1/2  
**KOCHER-LANGENBECK**  
12319-02 – 12319-20

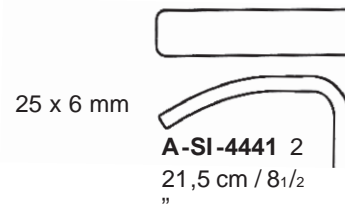

25 x 6 mm  
**A-SI-4441 2**  
21,5 cm / 8 1/2"

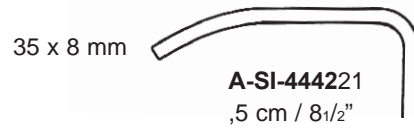

35 x 8 mm  
**A-SI-444221**  
,5 cm / 8 1/2"

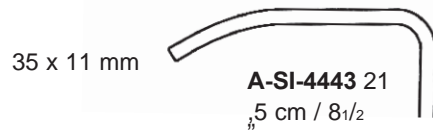

35 x 11 mm  
**A-SI-4443 21**  
,5 cm / 8 1/2"

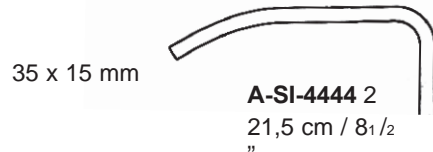

35 x 15 mm  
**A-SI-4444 2**  
21,5 cm / 8 1/2"

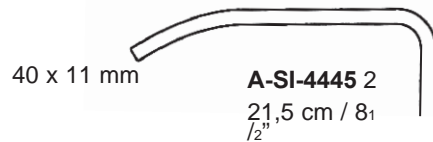

40 x 11 mm  
**A-SI-4445 2**  
21,5 cm / 8 1/2"

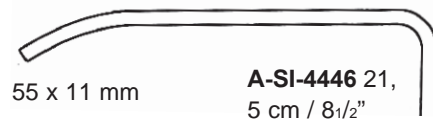

55 x 11 mm  
**A-SI-4446 21,**  
5 cm / 8 1/2"

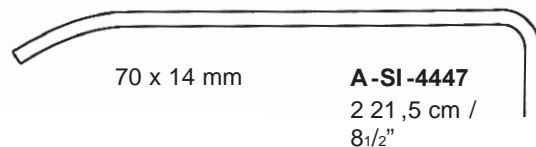

70 x 14 mm  
**A-SI-4447**  
2 21,5 cm / 8 1/2"

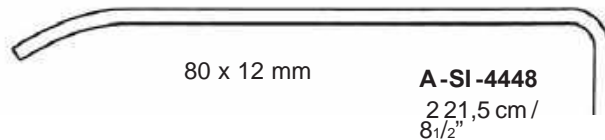

80 x 12 mm  
**A-SI-4448**  
2 21,5 cm / 8 1/2"

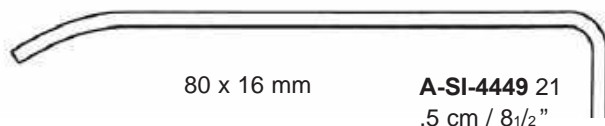

80 x 16 mm  
**A-SI-4449 21**  
,5 cm / 8 1/2"



1/2

KOCHER-  
LANGENBECK  
**A-SI-4464**  
**A-SI-4465**

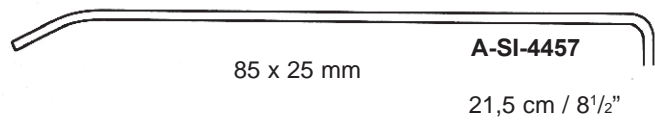
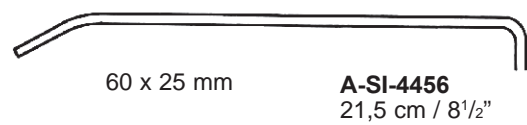
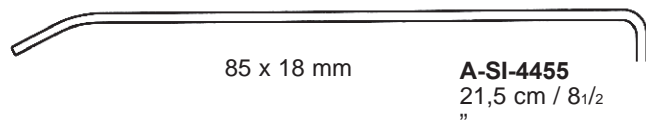
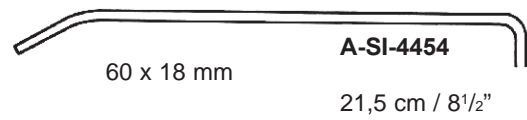
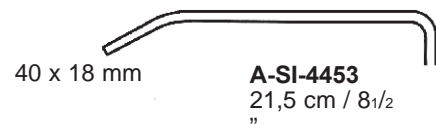
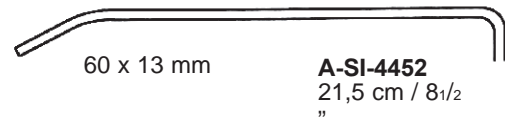
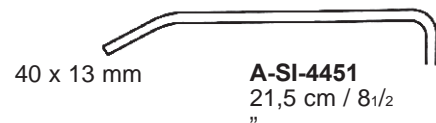
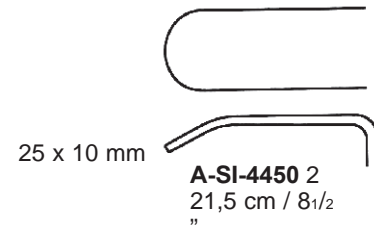



1/2  
**KOCHER**  
 22 cm / 8 3/4"

**A-SI-4459** = 40 x 10 mm **A-SI-4460** = 40 x 15 mm **A-SI-4461** = 40 x 20 mm



1/2  
**MIDDELDORPF**  
**A-SI-4466 A-SI-4467**

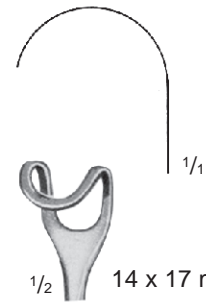

1/2 14 x 17 mm  
**A-SI-4458 21,**  
 5 cm / 8 1/2"

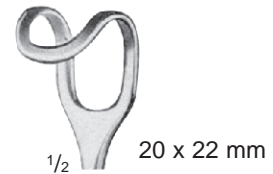

1/2 20 x 22 mm  
**A-SI-4462**  
 22 cm / 8 3/4"

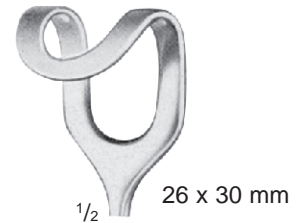

1/2 26 x 30 mm  
**A-SI-4463 23,**  
 5 cm / 9 1/4"



49 x 38 mm  
28 x 20 mm

Fig. 1

Fig. 2

36 x 28 mm  
63 x 49 mm

1/2

RICHARDSON-EASTMAN

**A-SI-4472** = - set

**A-SI-4473** = Fig. 1 = 26 cm / 10 1/4"

**A-SI-4474** = Fig. 2 = 28 cm / 11"

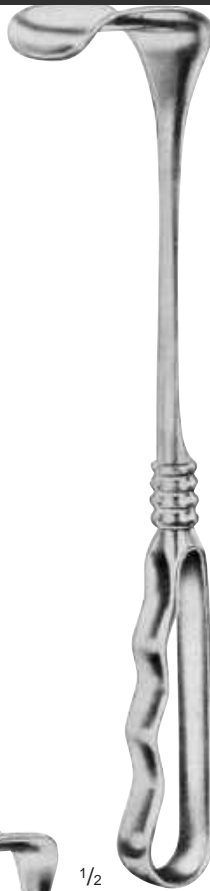

28 x 20 mm

1/2

**A-SI-4468**

36 x 28 mm

1/2

**A-SI-4469**

44 x 38 mm

1/2

**A-SI-4470**



65 x 50 mm

1/2

**KELLY A-SI-4471** 26 cm / 10 1/4"

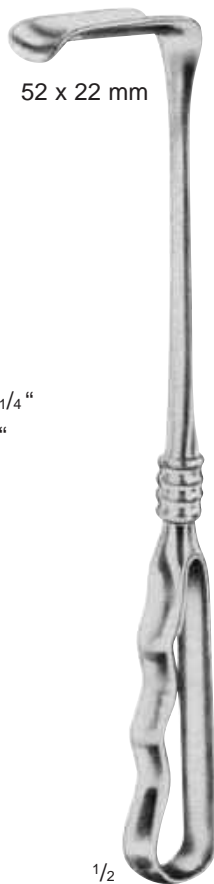

52 x 22 mm

1/2

**RICHARDSON**  
24 cm / 9 1/2"

1/2

**RICHARDSON**  
**A-SI-4481** 24  
cm / 9 1/2"

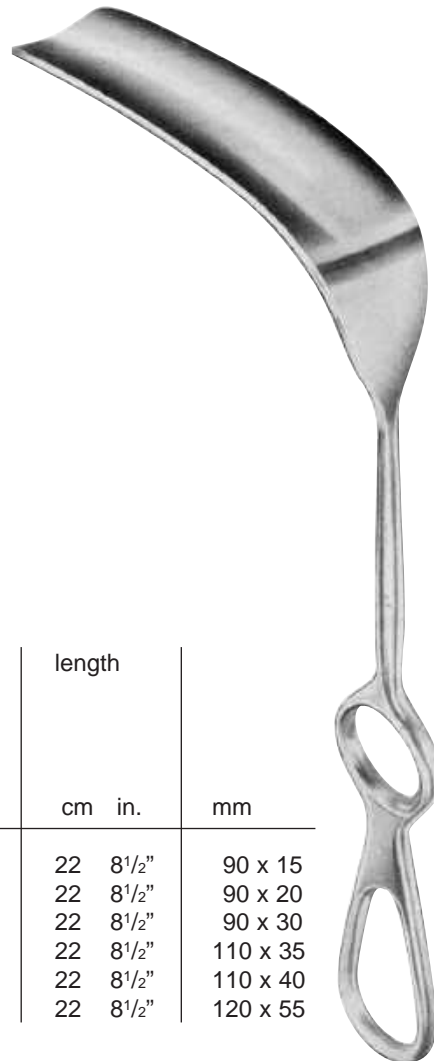

1/2

**DOYEN-STILLE**

|                  | length |        |          |
|------------------|--------|--------|----------|
|                  | cm     | in.    |          |
| <b>A-SI-4475</b> | 22     | 8 1/2" | 90 x 15  |
| <b>A-SI-4476</b> | 22     | 8 1/2" | 90 x 20  |
| <b>A-SI-4477</b> | 22     | 8 1/2" | 90 x 30  |
| <b>A-SI-4478</b> | 22     | 8 1/2" | 110 x 35 |
| <b>A-SI-4479</b> | 22     | 8 1/2" | 110 x 40 |
| <b>A-SI-4480</b> | 22     | 8 1/2" | 120 x 55 |



60 x 20 mm

**A-SI-4482** 26,0  
cm / 10<sup>1</sup>/<sub>4</sub>"

80 x 30 mm

**A-SI-4483** 26,0  
cm / 10<sup>1</sup>/<sub>4</sub>"

100 x 30 mm

**A-SI-4484** 26,0  
cm / 10<sup>1</sup>/<sub>4</sub>"

120 x 30 mm

**A-SI-4485** 26,0  
cm / 10<sup>1</sup>/<sub>4</sub>"

140 x 30 mm

**A-SI-4488** 26,0  
cm / 10<sup>1</sup>/<sub>4</sub>"

140 x 40 mm

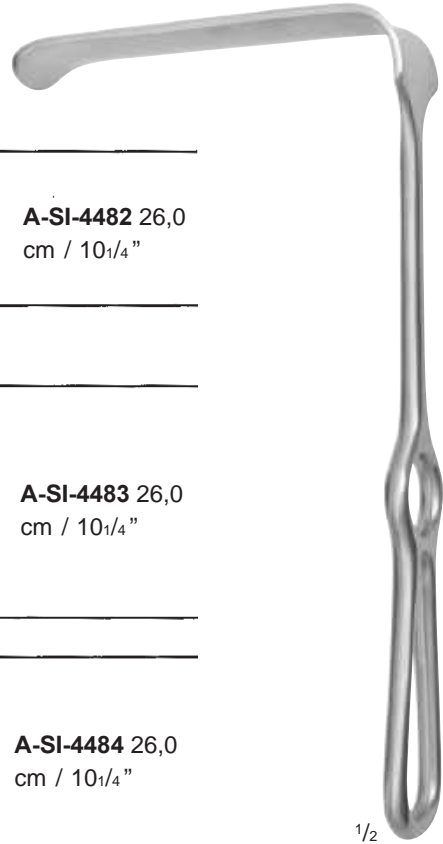
**A-SI-4489** 26,0  
cm / 10<sup>1</sup>/<sub>4</sub>"

1/2

HÖSEL

**A-SI-4486 A-SI-4487**

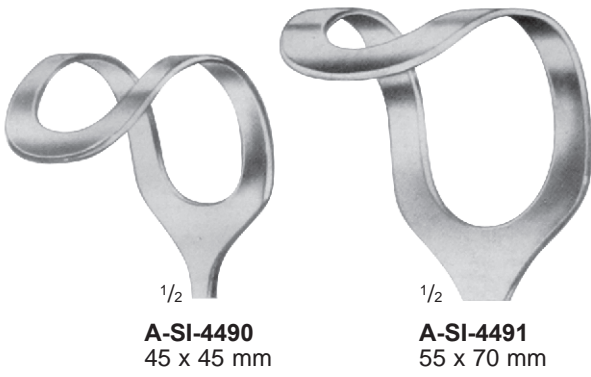

$\frac{1}{2}$   
**A-SI-4490**  
45 x 45 mm

$\frac{1}{2}$   
**A-SI-4491**  
55 x 70 mm



$\frac{1}{2}$   
**MIDDELDORPF**  
**A-SI-4492**  
25,5 cm / 10"  
45 x 50 mm



$\frac{1}{2}$   
**FRITSCH**

|                  | length |                   | mm      |
|------------------|--------|-------------------|---------|
|                  | cm     | in.               |         |
| <b>A-SI-4493</b> | 24     | 9 $\frac{1}{2}$ " | 45 x 40 |
| <b>A-SI-4494</b> | 24     | 9 $\frac{1}{2}$ " | 45 x 50 |
| <b>A-SI-4495</b> | 24     | 9 $\frac{1}{2}$ " | 45 x 60 |
| <b>A-SI-4496</b> | 24     | 9 $\frac{1}{2}$ " | 45 x 75 |



50 x 85 mm

1/2

**DOYEN**  
**A-SI-4498**  
25 cm / 10"

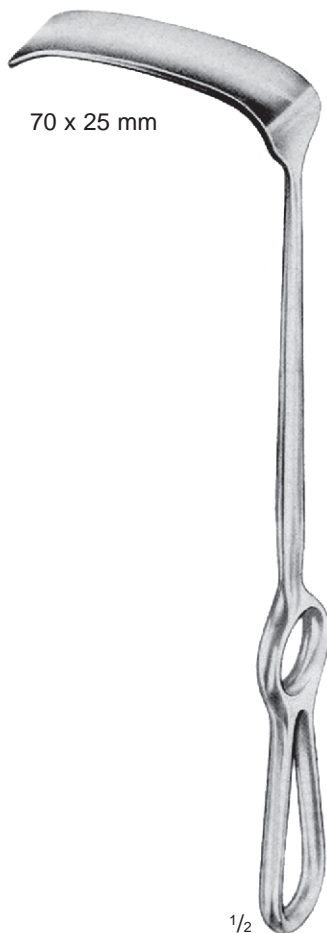

70 x 25 mm

1/2

**KOCHER**  
**A-SI-4499**  
22,5 cm / 9"

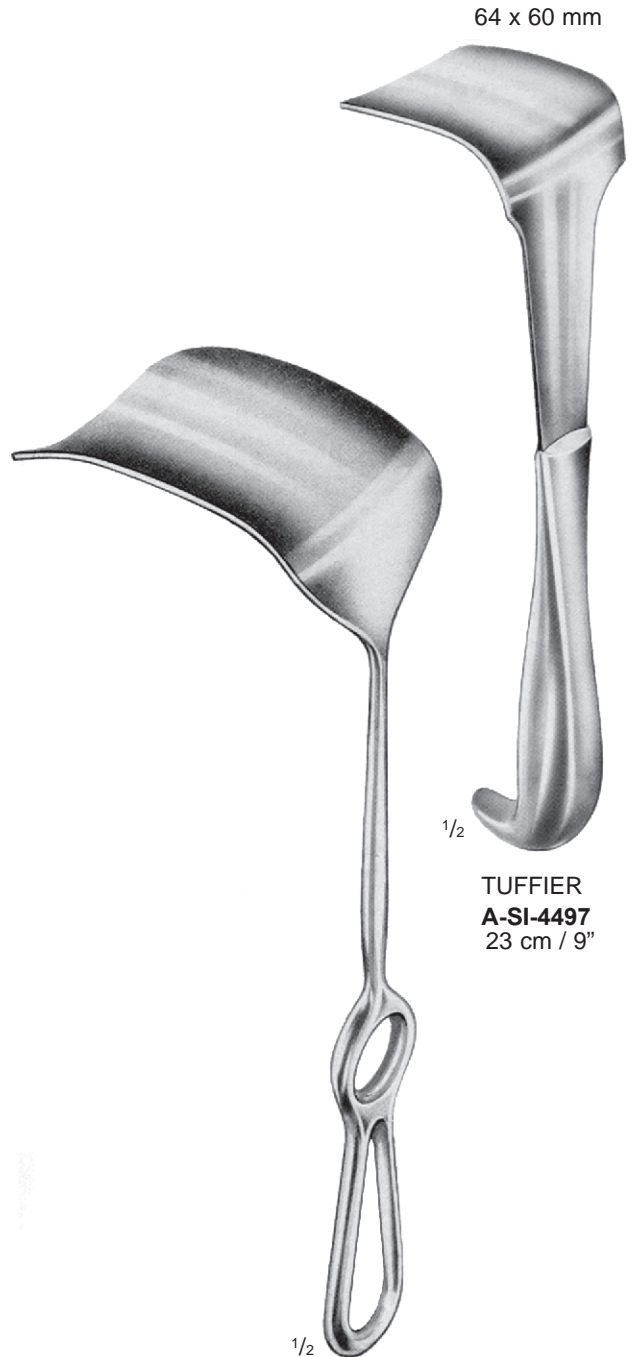

64 x 60 mm

1/2

**TUFFIER**  
**A-SI-4497**  
23 cm / 9"

1/2

**KOCHER**

|                  | length |     | mm      |
|------------------|--------|-----|---------|
|                  | cm     | in. |         |
| <b>A-SI-4500</b> | 25     | 10" | 80 x 45 |
| <b>A-SI-4501</b> | 25     | 10" | 80 x 55 |
| <b>A-SI-4502</b> | 25     | 10" | 80 x 65 |





Retractors



**ARTIFED**  
INTERNATIONAL

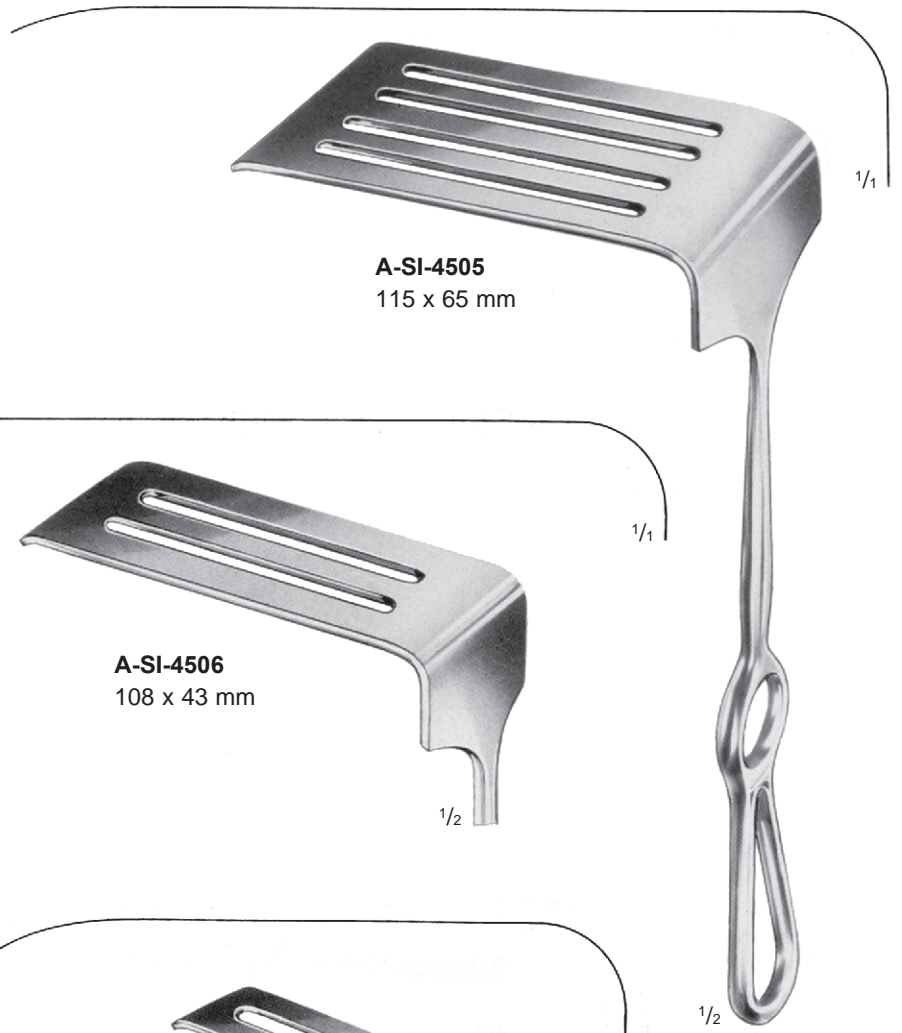

**A-SI-4505**  
115 x 65 mm

**A-SI-4506**  
108 x 43 mm

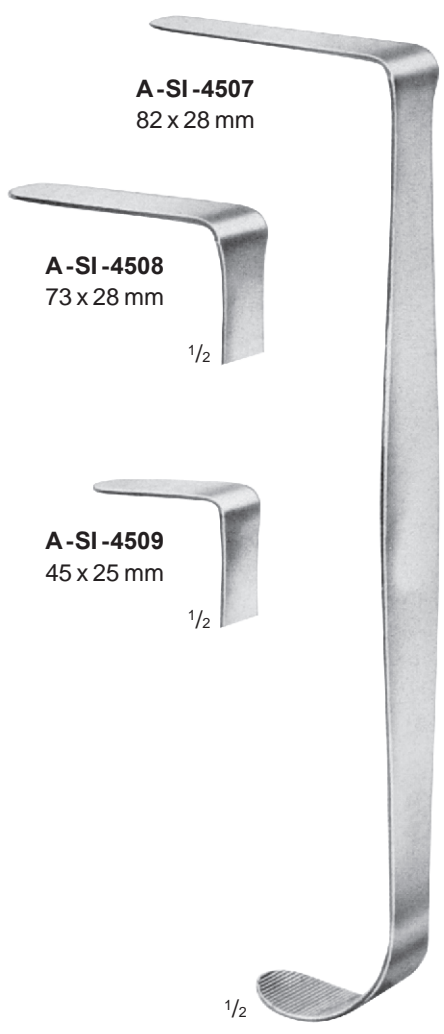

**A-SI-4507**  
82 x 28 mm

**A-SI-4508**  
73 x 28 mm

**A-SI-4509**  
45 x 25 mm

**HEANEY**  
27 cm / 10 1/2"



**A-SI-4510**  
82 x 22 mm

**CORYLLOS**  
24 cm / 9 1/2"



DAVIDSON  
16 cm / 6 1/4"



1/2

**A-SI-4511**  
75 x 50 mm

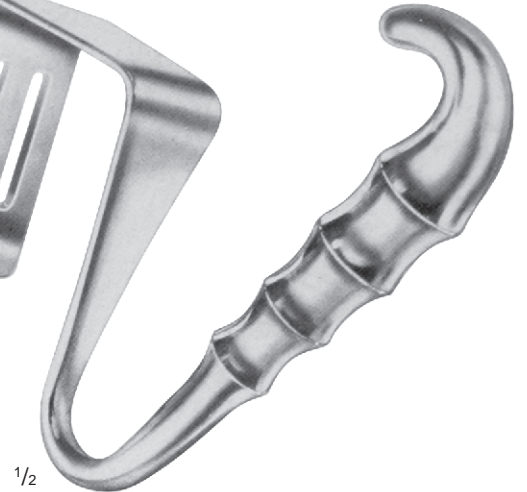

1/2

**A-SI-4512**  
75 x 90 mm



125 x 37 mm

1/1

SAUERBRUCH  
**A-SI-4513** 25  
cm / 10"

1/2



Retractors

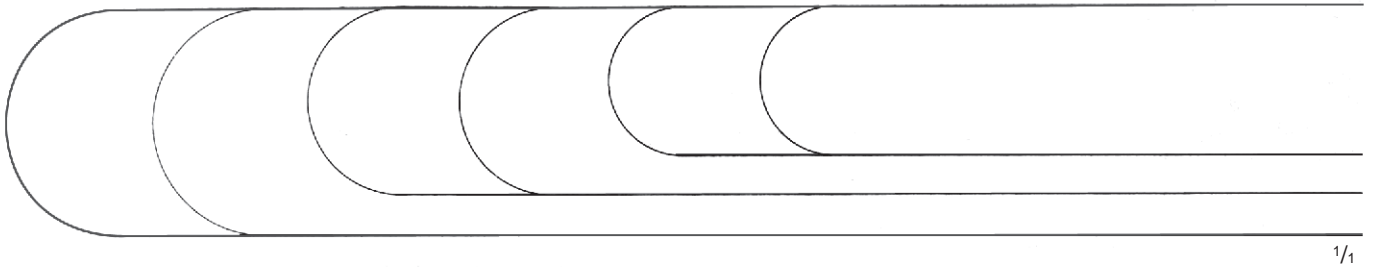
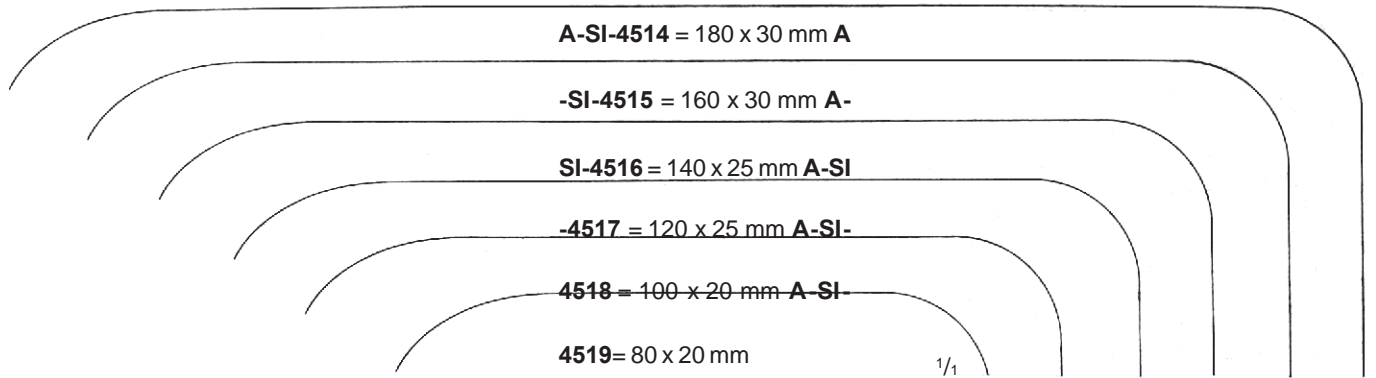

BRUNNER A-SI-4524 25 cm / 10"



SAUERBRUCH 22,5 cm / 9"



A-SI-4520 45 x 15 mm

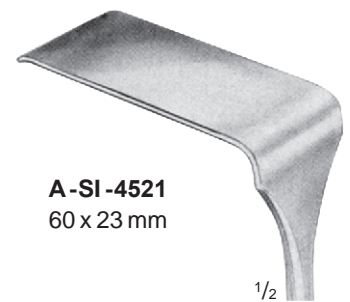

A-SI-4521 60 x 23 mm



A-SI-4523 75 x 20 mm



1/1

flexible



1/2

ROSS  
**A-SI-4531 A-SI-4532**  
25,5 cm / 10"



**FIG. 1 A-SI-4525**



**FIG. 2 A-SI-4526**



**FIG. 3 A-SI-4528**



**FIG. 4 A-SI-4529**



**FIG. 5 A-SI-4530**



**FIG. 6 A-SI-4533**

1/2

**POLLOSON**  
**A-SI-4527** 27  
cm / 10<sup>3</sup>/<sub>4</sub>"

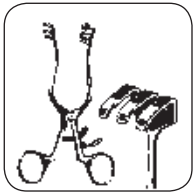

Retractors

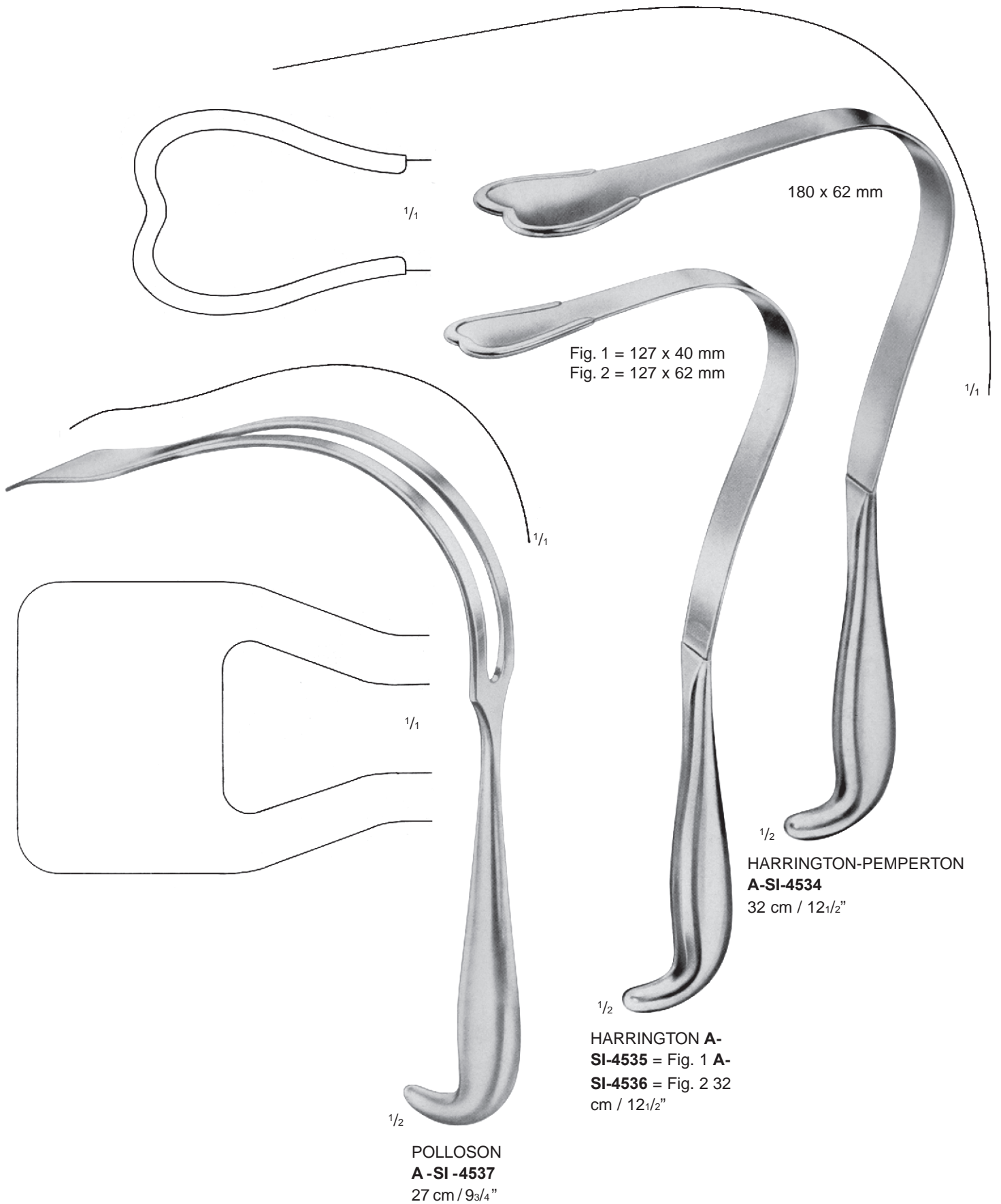





38 mm

75 mm

50 mm

1/2

**DEAVER A-  
SI-4544** 30  
cm / 12"

1/2

**DEAVER A  
-SI-4545**  
30 cm / 12"

1/2

**DEAVER A  
-SI-4550**  
30 cm / 12"

1/2

**DEAVER A-  
SI-4546 A-SI** 25 mm  
**-447 A-SI-** 35 mm  
**4548 A-SI-** 50 mm  
**4549** 32-cm /  
12-1/2"



rechts  
right

COOLEY  
**A-SI-4551**  
25,0 cm / 9<sup>3</sup>/<sub>4</sub>"  
48 x 48 mm



right, serrated

COOLEY  
**A-SI-4552**  
25,0 cm / 9<sup>3</sup>/<sub>4</sub>"  
48 x 48 mm



links left

COOLEY A-  
**SI-4553** 25,0  
cm / 9<sup>3</sup>/<sub>4</sub>" 30  
x 48 mm

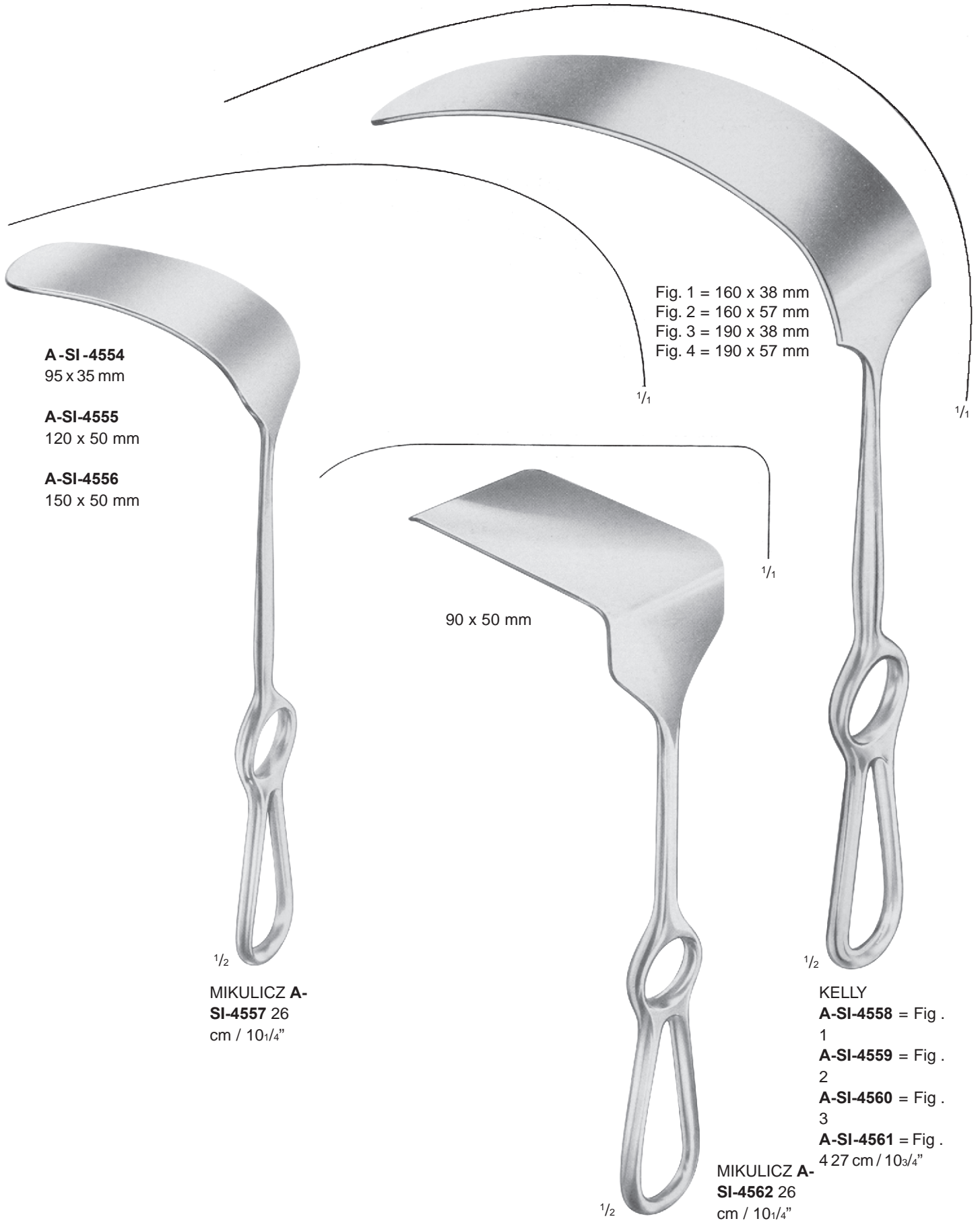

**A-SI-4554**  
95 x 35 mm

**A-SI-4555**  
120 x 50 mm

**A-SI-4556**  
150 x 50 mm

Fig. 1 = 160 x 38 mm  
Fig. 2 = 160 x 57 mm  
Fig. 3 = 190 x 38 mm  
Fig. 4 = 190 x 57 mm

**MIKULICZ A-SI-4557** 26 cm / 10 1/4"

**KELLY A-SI-4558** = Fig. 1  
**A-SI-4559** = Fig. 2  
**A-SI-4560** = Fig. 3  
**A-SI-4561** = Fig. 4  
27 cm / 10 3/4"

**MIKULICZ A-SI-4562** 26 cm / 10 1/4"

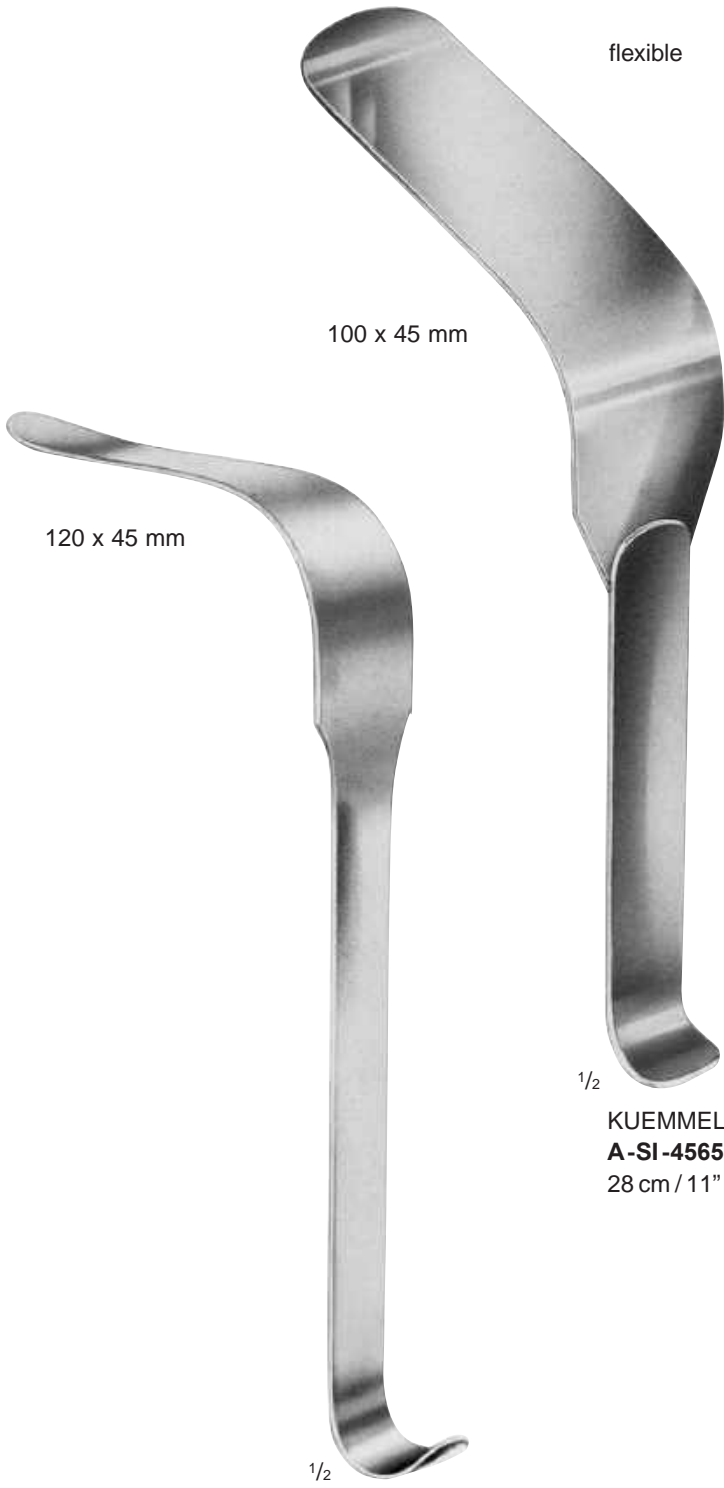

flexible  
100 x 45 mm  
  
120 x 45 mm  
  
1/2  
KUEMMEL  
**A-SI-4565**  
28 cm / 11"



1/2  
KADER **A-SI-4566 A-SI-4567** 28,0 cm / 11"



20 mm  
**A-SI-4562**  
28,0 cm / 11"

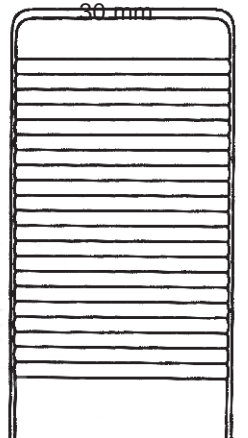

30 mm  
**A-SI-4563**  
28,0 cm / 11"

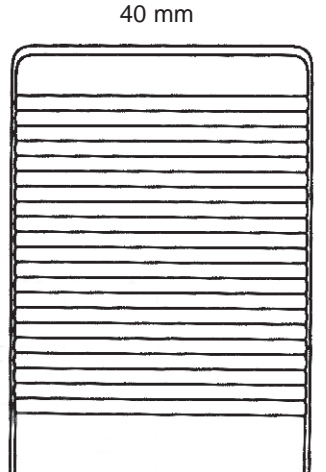

40 mm  
**A-SI-4568**  
28,0 cm / 11"

1/2  
**KOERTE A-SI-4564**  
28 cm / 11"

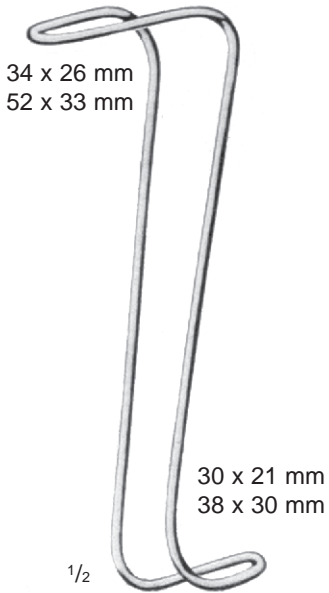

**COLLIN-HARTMANN A-SI**  
**-4569 = 14 cm / 5 1/2" A-SI-**  
**4570 = 16 cm / 6 1/4"**

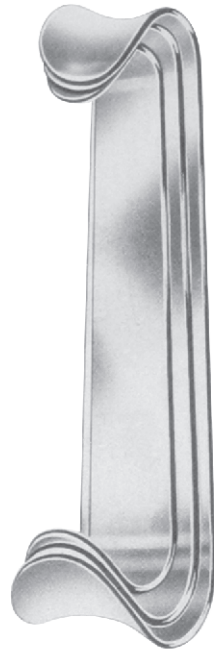

**ROUX**  
**A-SI-4571 = set**

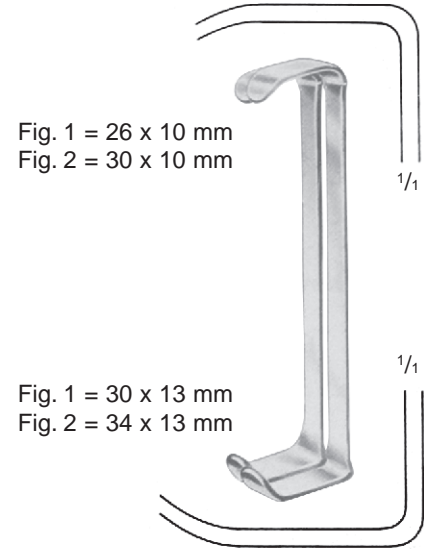
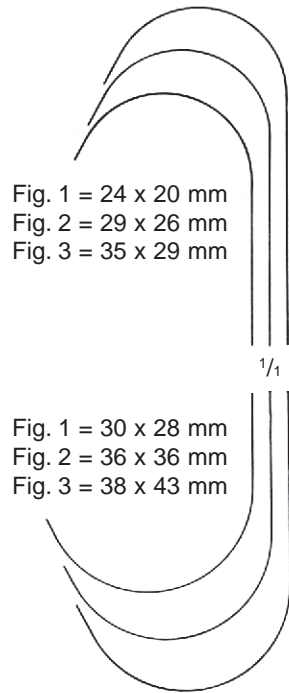

**FARABEUF 12**  
**cm / 4 3/4" A-SI-**  
**4572 -set**

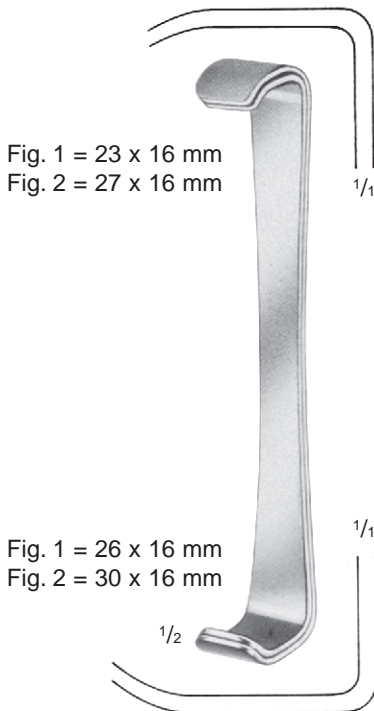

**FARABEUF 15**  
**cm / 6" A-SI-**  
**4573= set**

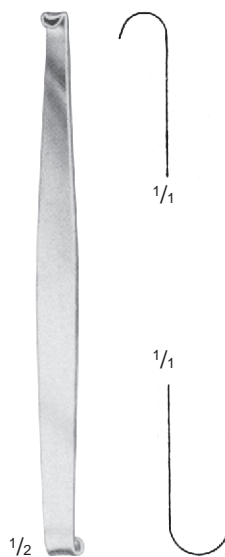

**MINI-ROUX**  
**A-SI-4574**  
**14 cm / 5 1/2"**



**BABY-ROUX**  
**A-SI-4575**  
**13 cm / 5 1/4"**

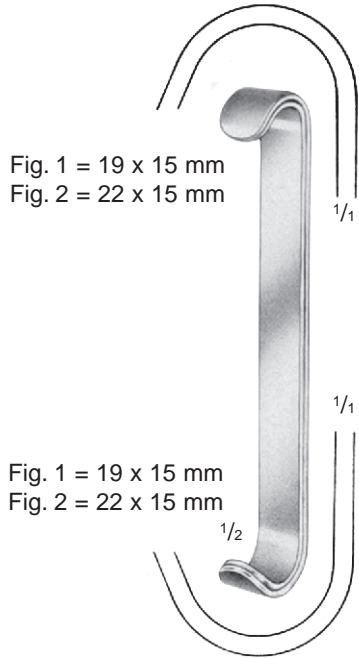

Fig. 1 = 19 x 15 mm  
Fig. 2 = 22 x 15 mm

Fig. 1 = 19 x 15 mm  
Fig. 2 = 22 x 15 mm

**PARKER 13,5 cm**  
**/ 5 1/4" A-SI-4576**  
= set

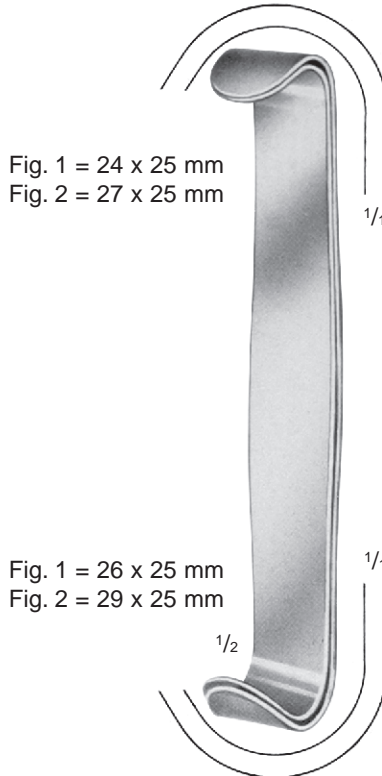

Fig. 1 = 24 x 25 mm  
Fig. 2 = 27 x 25 mm

Fig. 1 = 26 x 25 mm  
Fig. 2 = 29 x 25 mm

**PARKER**  
**18 cm / 7"**  
**A-SI-4577**  
= set

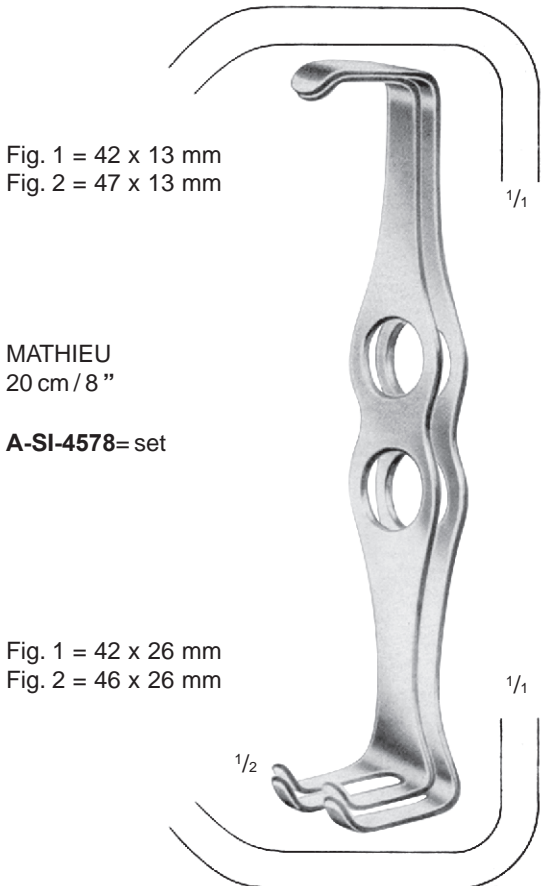

Fig. 1 = 42 x 13 mm  
Fig. 2 = 47 x 13 mm

**MATHIEU**  
**20 cm / 8"**  
**A-SI-4578= set**

Fig. 1 = 42 x 26 mm  
Fig. 2 = 46 x 26 mm



Fig. 1 = 21 x 24 mm  
Fig. 2 = 25 x 24 mm

**PARKER-LANGENBECK**  
**21 cm / 8 1/4"**  
**A-SI-4579 = set**

Fig. 1 = 40 x 15 mm  
Fig. 2 = 40 x 15 mm



37 x 40 mm

**GOELET A-SI-4580**  
**19 cm / 7 1/2"**

30 x 31 mm



sharp



blunt

**A-SI-4582**  
5 cm / 2"

FINSEN

**A-SI-45783**  
5 cm / 2"

sharp



blunt

**A-SI-4584**  
7 cm / 2 3/4"

FINSEN

**A-SI-4585**  
7 cm / 2 3/4"

sharp



blunt **A-SI-4587**  
7 cm / 2 3/4"

**A-SI-4586**  
7 cm / 2 3/4"

FINSEN

1/2



**LOGAN A-SI-4588**  
4 cm / 1 1/2"

1/2



**BUCKLEY A-SI-4589**  
6 cm / 2 1/4"

sharp

sharp



blunt

**A-SI-4592** 7 cm / 2 3/4" **A-SI-4593** 7 cm / 2 3/4" **A-SI-4590** 10 cm / 4" **A-SI-4591** 10 cm / 4"

1/2

ALM

sharp



stumpf

**A-SI-4594** 10 cm / 4" **A-SI-4595** 10 cm / 4"

HOLTZHEIMER

sharp



blunt

**A-SI-4596**  
10 cm / 4"

JANSEN

**A-SI-4597**  
10 cm / 4"

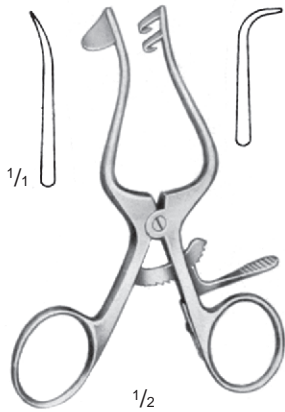

**PLESTER**  
**A-SI-4598**  
11 cm / 4 1/4"  
" blunt

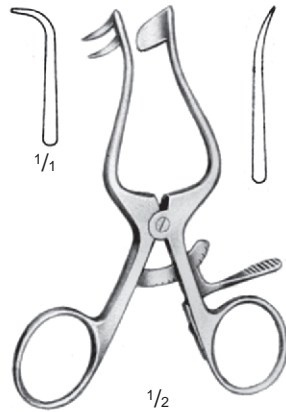

**PLESTER A**  
**-SI-4599** 11  
cm / 4 1/4"  
blunt

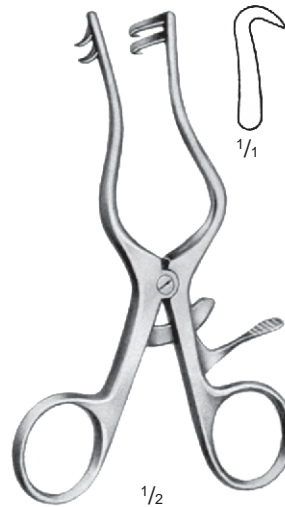

**PLESTER A**  
**-SI-4600** 11  
cm / 4 1/4" **A-**  
**SI-4601**  
13 cm / 5"  
sharp

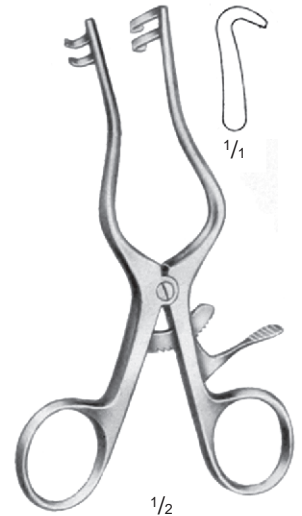

**PLESTER A**  
**-SI-4602** 11  
cm / 4 1/4" **A-**  
**SI-4603**  
13 cm / 5"  
blunt



**WEITLANER**  
**A-SI-4604 A-SI-4605** 10,5 cm  
/ 4" 10,5 cm / 4"  
sharp blunt



**WEITLANER**  
**A-SI-4606 A-SI-4607** 13  
cm / 5" 13 cm / 5"  
sharp blunt



**WEITLANER**  
**A-SI-4608 A-SI-4609** 16 cm /  
6 1/4" 16 cm / 6 1/4"  
sharp blunt

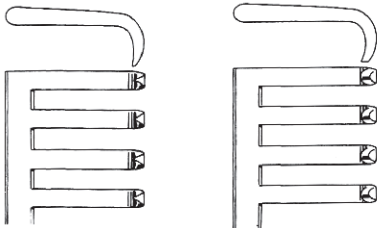

komplett mit 3 Mittelvalven  
Art.-Nr. 1 **A-SI-4612/A-SI-4613/A-SI-4614**

complete with 3 central blades  
ref. **A-SI-4615/A-SI-4616/A-SI-4617**

completo con 3 valvas centrales  
ref. **A-SI-4618/A-SI-4619/A-SI-4620**

complet avec 3 valves centrales  
ref. **A-SI-4621/A-SI-4622/A-SI-4623**

completo con 3 valve centrali  
rif. **A-SI-4624/A-SI-4625/A-SI-4626**

HENLEY

**A-SI-4610**    **A-SI-4611** 16  
cm / 6 1/4"    16 cm / 6 1/4"  
sharp            blunt



1/2

**HENLEY A**  
**-SI-4630 A**  
**-SI-4631**

19 x 16 mm

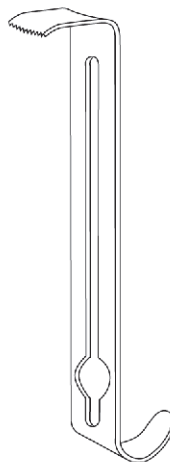

**A-SI-4627**

25 x 16 mm

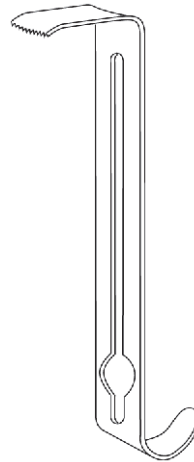

**A-SI-4628**

32 x 16 mm

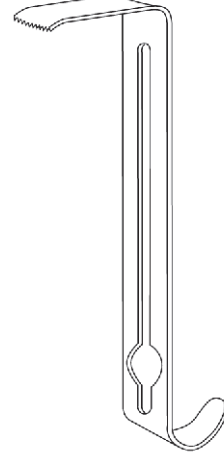

**A-SI-4629**



**WEITLANER**  
**A-SI-4633**  
20 cm / 8"  
sharp



**A-SI-4634**  
20 cm / 8"  
blunt

**WEITLANER A-SI-**  
**A-SI-4635** 24 cm / 9 1/2"  
sharp

**4636** 24 cm / 9 1/2"  
blunt

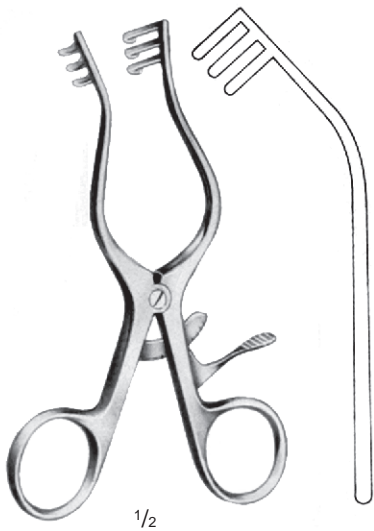

**WULLSTEIN A-SI-**  
**A-SI-4638** 10 cm / 4"  
sharp

**4639** 10 cm / 4"  
**12738-13** 13 cm / 5"  
**12739-13** 13 cm / 5"  
blunt



**MILLIGAN**  
**A-SI-4640**  
13 cm / 5"  
blunt



**WEITLANER-**  
**BABY A-SI-4641**  
14 cm / 5 1/2"



**A-SI-4637**  
40 mm



**A-SI-4643**  
45 mm



**A-SI-4645**  
50 mm



**A-SI-4647**  
55 mm



**A-SI-4649**  
60 mm



**A-SI-4642**  
40 mm



**A-SI-4644**  
45 mm



**A-SI-4646**  
50 mm



**A-SI-4648**  
55 mm



**A-SI-4650**  
60 mm

60 mm

CLOWARD 12747

-  
15 15,0 cm / 9<sup>3</sup>/<sub>4</sub>"  
" Spreader only



CLOWARD  
**A-SI-4651**  
0 cm / 9<sup>3</sup>/<sub>4</sub>"

complete, with 2 each plug-in blades (12746-40 + 12746-60)



CLOWARD  
**A-SI-4652**  
15,0 cm / 6"

complete, with 2 each plug-in blades (12747-40 + 12747-60)



**A-SI-4653**      **ADSON A-SI-4654**  
20 cm / 8"      20 cm / 8"  
sharp              blunt



**A-SI-4655**      **ADSON A-SI-4656**  
20 cm / 8"      20 cm / 8"  
sharp              blunt



**A-SI-4657**      **ADSON A-SI-4658**  
26 cm / 10 1/4"      26 cm / 10 1/4"  
sharp              blunt



ADSON  
**A-SI-4659**      **A-SI-4660**  
 27 cm / 10<sup>3</sup>/<sub>4</sub>"      27 cm / 10<sup>3</sup>/<sub>4</sub>"  
 sharp              blunt



ADSON  
**A-SI-4661**      **A-SI-4662**  
 27 cm / 10<sup>3</sup>/<sub>4</sub>"      27 cm / 10<sup>3</sup>/<sub>4</sub>"  
 sharp              blunt



ADSON  
**A-SI-4663**      **A-SI-4664**  
 27 cm / 10<sup>3</sup>/<sub>4</sub>"      27 cm / 10<sup>3</sup>/<sub>4</sub>"  
 sharp              blunt

Retractors



**CONE**  
(ADSON-BABY)  
**A-SI-4665**  
**A-SI-4666**  
14 cm / 5 1/2"      14 cm /  
5 1/2"      sharp      blunt



**1/2 CONE**  
(ADSON-BABY)  
**A-SI-4667**  
**A-SI-4668**  
16 cm / 6 1/4"      16 cm / 6 1/4"  
sharp      blunt

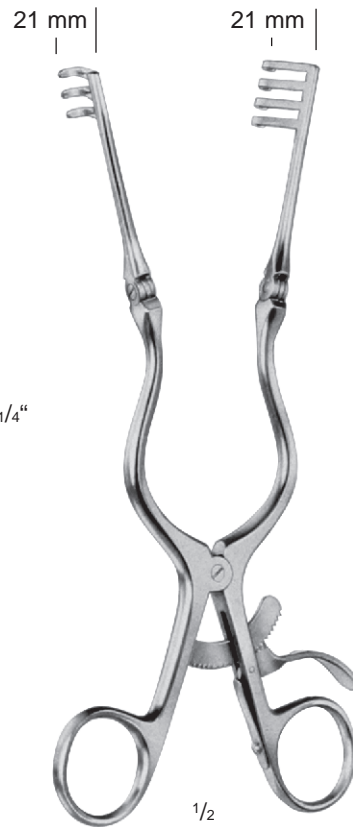

**1/2 CONE**  
**A-SI-4669**      **A-SI-4670**  
20 cm / 8"      20 cm / 8"  
scharf      blunt



**1/2 CONE**  
**A-SI-4671**      **A-SI-4672**  
25 cm / 10"      25 cm / 10"  
sharp      blunt

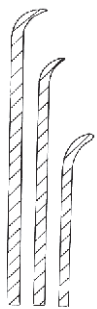

with 3 pairs of blades



**1/4 CHANDLER**  
**A-SI-4673**  
25 cm / 10"

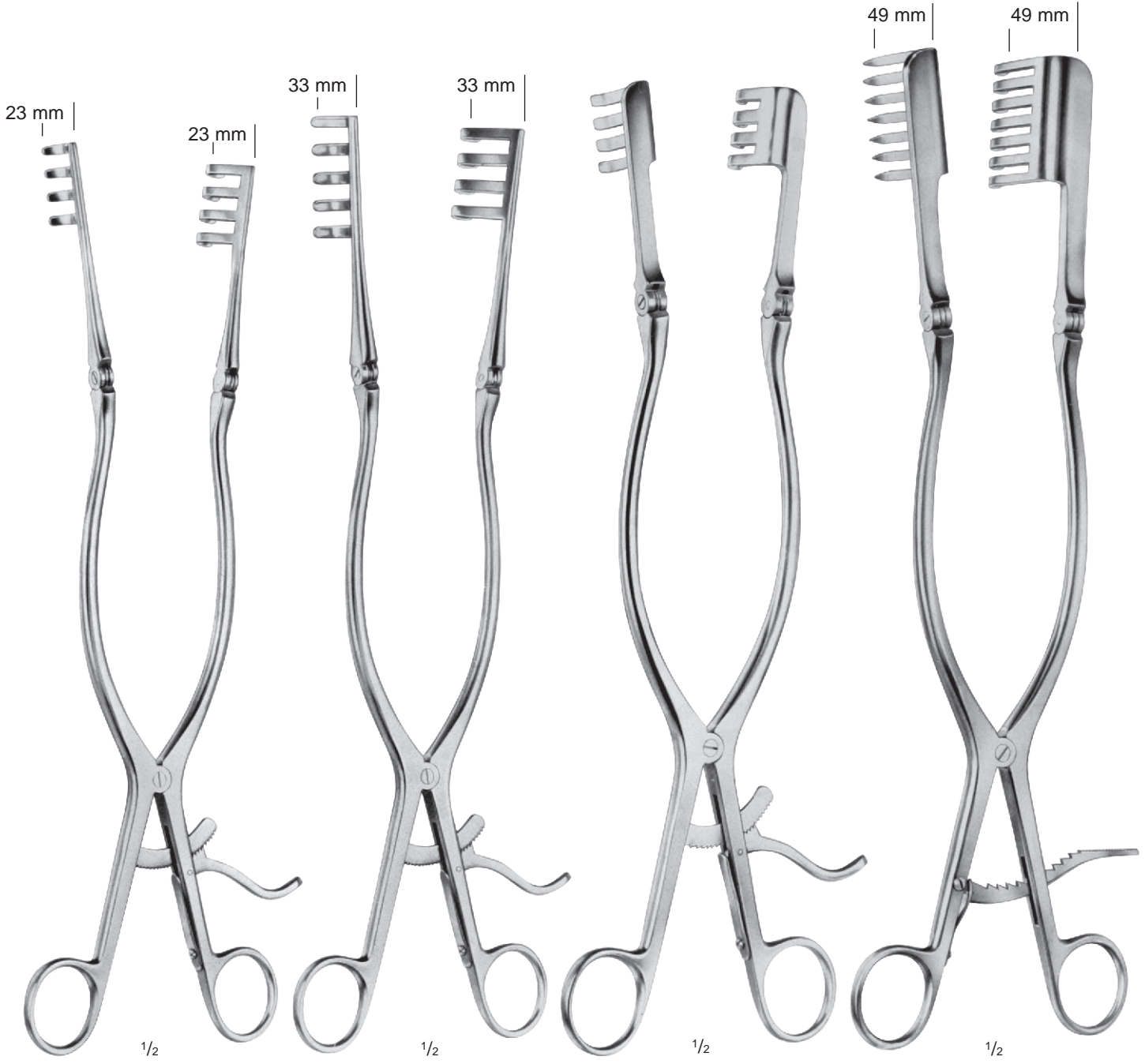

|                  |                  |                  |                  |  |  |                  |
|------------------|------------------|------------------|------------------|--|--|------------------|
| BECKMANN         |                  | BECKMANN         |                  | BECKMANN-ADSON                           |  | BECKMANN-EATON   |
| <b>A-SI-4674</b> | <b>A-SI-4675</b> | <b>A-SI-4676</b> | <b>A-SI-4677</b> | <b>A-SI-4678</b> 25 x 25 mm, 1" x 1"     | <b>A-SI-4679</b> 25 x 31 mm, 1" x 1 1/4" | <b>A-SI-4682</b> |
| 31 cm / 12 1/4"  | 31 cm / 12 1/4"  | 33 cm / 13"      | 33 cm / 13"      | <b>A-SI-4680</b> 25 x 40 mm, 1" x 1 1/2" | <b>A-SI-4681</b> 25 x 45 mm, 1" x 1 3/4" | 33 cm / 13"      |
| sharp            | blunt            | sharp            | blunt            | halbscharf, semi-sharp,                  |  | "sharp"          |

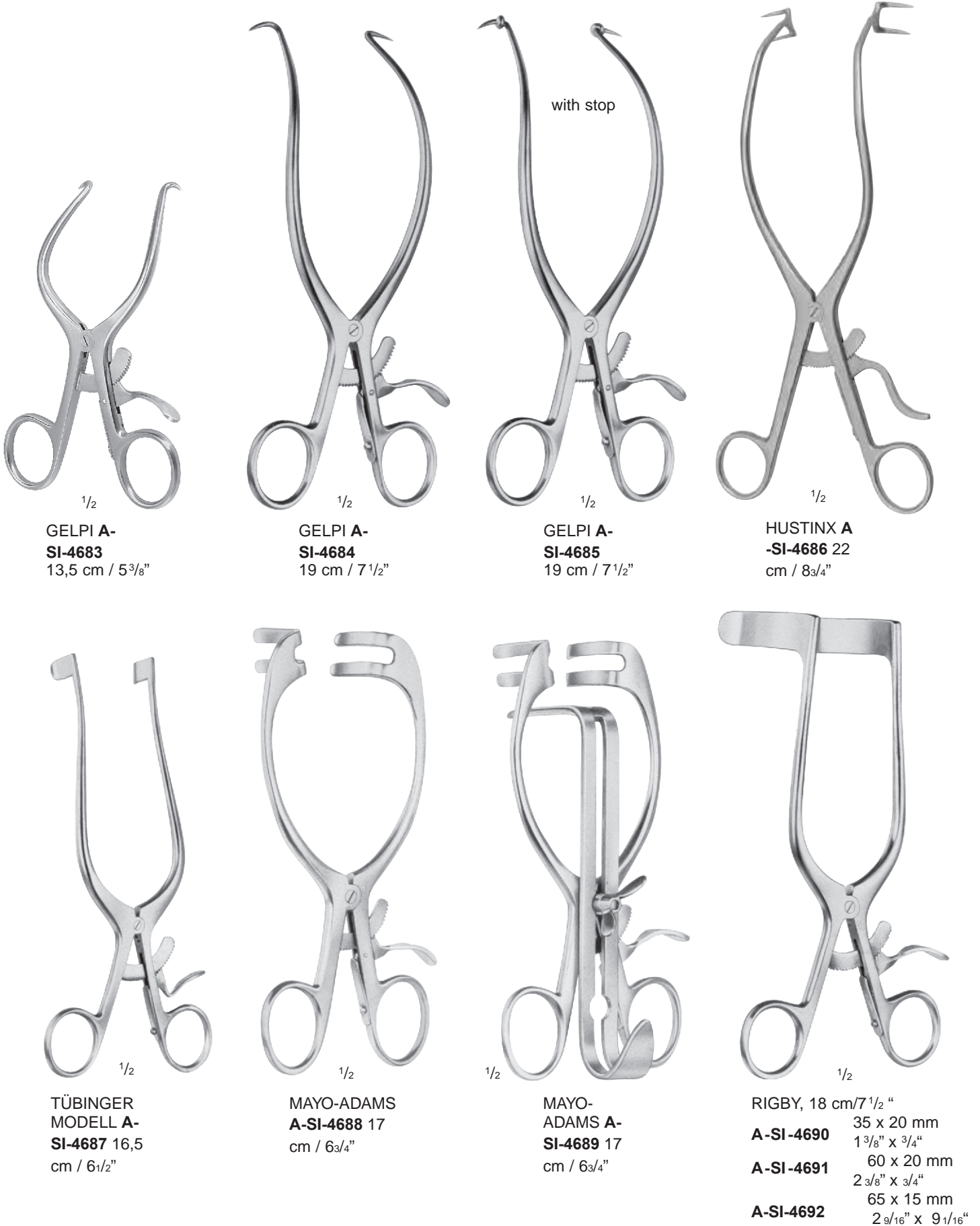

with stop

1/2

**GELPI A-  
SI-4683**  
13,5 cm / 5 3/8"

1/2

**GELPI A-  
SI-4684**  
19 cm / 7 1/2"

1/2

**GELPI A-  
SI-4685**  
19 cm / 7 1/2"

1/2

**HUSTINX A  
-SI-4686 22**  
cm / 8 3/4"

1/2

**TÜBINGER  
MODELL A-  
SI-4687** 16,5  
cm / 6 1/2"

1/2

**MAYO-ADAMS  
A-SI-4688** 17  
cm / 6 3/4"

1/2

**MAYO-  
ADAMS A-  
SI-4689** 17  
cm / 6 3/4"

1/2

**RIGBY, 18 cm/7 1/2 "**  
**A-SI-4690** 35 x 20 mm  
1 3/8" x 3/4"  
**A-SI-4691** 60 x 20 mm  
2 3/8" x 3/4"  
**A-SI-4692** 65 x 15 mm  
2 9/16" x 9 1/16"



Abdominal Retractors



COLLIN-BABY  
**A-SI-4693**  
 18 cm / 7"  
 2 pair of blades



COLLIN  
**A-SI-4694**  
 22 cm / 8 3/4" 32  
 mm x 62 mm 1 1/2"  
 x 2 3/8"



COLLIN, 22 cm / 8 3/4"  
**A-SI-4695** 32 x 62 mm 55 x 55 mm  
 1 1/2" x 2 3/8" 2 1/8" x 2 1/8"  
**A-SI-4696** 38 x 80 mm 55 x 65 mm  
 1 1/2" x 3 1/8" 2 1/8" x 2 1/2"  
**A-SI-4697** 38 x 100 mm 55 x 75 mm  
 1 1/2" x 4" 2 1/8" x 3"  
 lateral blades center blade



1/3

**ROBIN-MASSE**

**A-SI-4698** 38 x 64 mm 40 x 64 mm

1 1/2" x 2 1/2"

lateral blades

1 5/8" x 2 1/2"

center blade



1/3

**RICARD**

**A-SI-4699** 60 x 80 mm 55 x 70 mm

2 1/4" x 3 1/4"

2 1/8" x 2 3/4"

**A-SI-4700** 72 x 85 mm 80 x 90 mm

2 3/4" x 3 3/8" 3 1/4" x 3 1/2"

lateral blades

center blade



1/3

**HOLZBACH**

**A-SI-4701** 62 x 80 mm 80 x 80 mm

2 1/2" x 3 1/4"

lateral blades

3 1/4" x 3 1/4"

center blade



| GOSSET           | A     | B     | C      |
|------------------|-------|-------|--------|
| <b>A-SI-4703</b> | 38 mm | 19 mm | 100 mm |

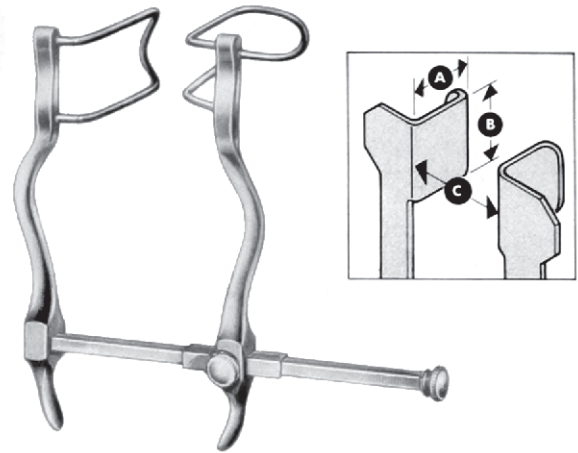

| GOSSET           | A     | B     | C      |
|------------------|-------|-------|--------|
| <b>A-SI-4704</b> | 38 mm | 19 mm | 100 mm |



| GOSSET           | A     | B     | C      |
|------------------|-------|-------|--------|
| <b>A-SI-4705</b> | 64 mm | 25 mm | 140 mm |



| GOSSET           | A     | B     | C      |
|------------------|-------|-------|--------|
| <b>A-SI-4706</b> | 64 mm | 25 mm | 160 mm |



| HERTZLER         | A     | B     | C     |
|------------------|-------|-------|-------|
| <b>A-SI-4707</b> | 25 mm | 25 mm | 70 mm |

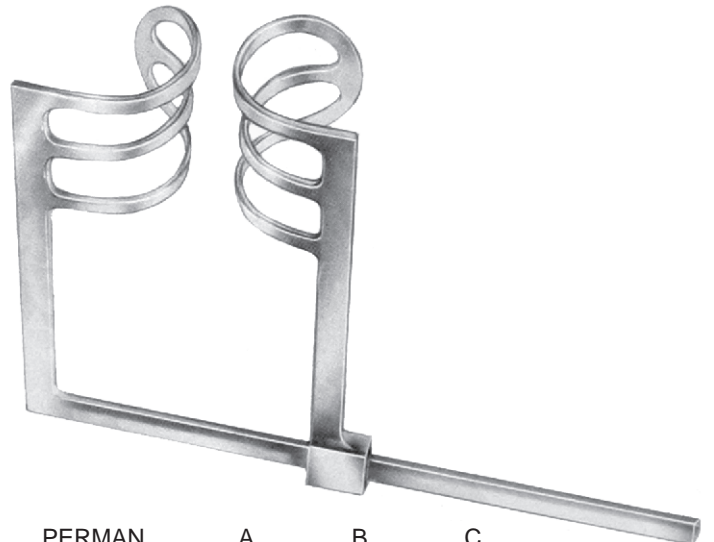

| PERMAN           | A     | B     | C      |
|------------------|-------|-------|--------|
| <b>A-SI-4708</b> | 65 mm | 65 mm | 180 mm |

Abdominal Retractors

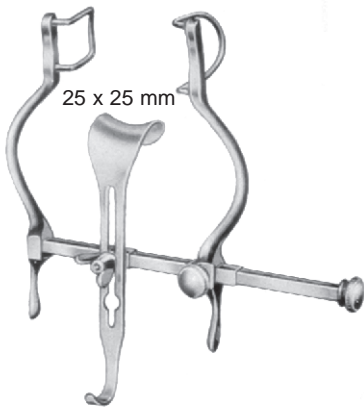

| BALFOUR-BABY     | A     | B     | C     |
|------------------|-------|-------|-------|
| <b>A-SI-4709</b> | 36 mm | 25 mm | 95 mm |



| BALFOUR          | A     | B     | C      |
|------------------|-------|-------|--------|
| <b>A-SI-4710</b> | 50 mm | 38 mm | 180 mm |

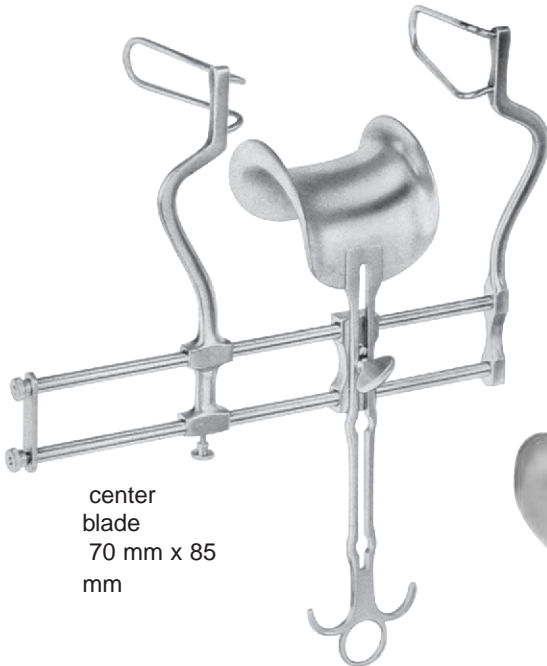
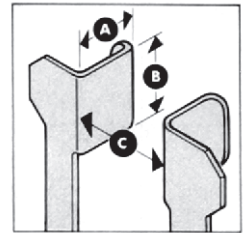

| BALFOUR          | A      | B     | C      |
|------------------|--------|-------|--------|
| <b>A-SI-4711</b> | 100 mm | 40 mm | 250 mm |

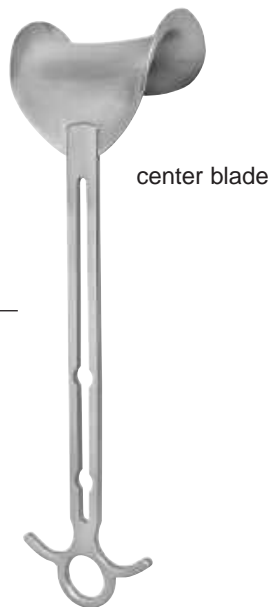

**A-SI-4713** 68 x 85 mm  
**A-SI-4714** 40 x 68 mm

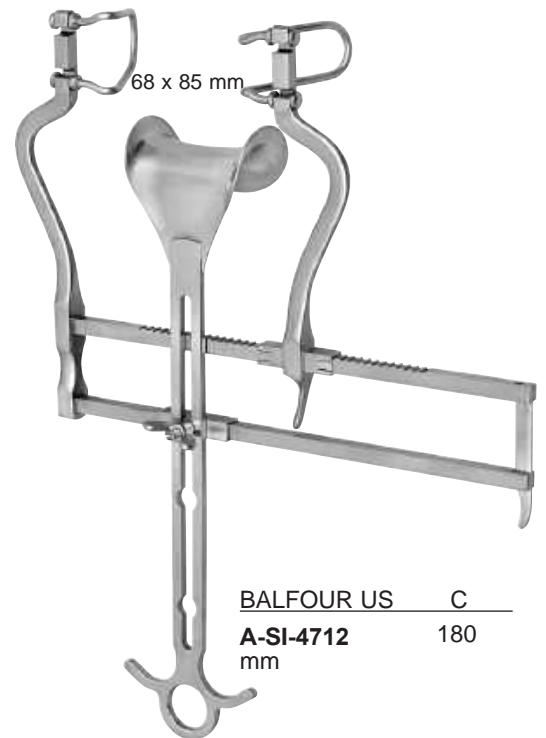

| BALFOUR US       | C      |
|------------------|--------|
| <b>A-SI-4712</b> | 180 mm |

Fenestrated blades

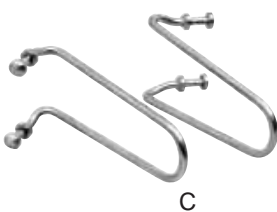

**A-SI-4716** 60 mm

**A-SI-4715** 80 mm

with 1 pairs of each lateral blades **12869-06 +12869-08** and 1 central blade **12869-01**



| BALFOUR          | A     | B     | C      |
|------------------|-------|-------|--------|
| <b>A-SI-4717</b> | 70 mm | 35 mm | 180 mm |



| BALFOUR          | A      | B     | C      |
|------------------|--------|-------|--------|
| <b>A-SI-4718</b> | 100 mm | 35 mm | 180 mm |

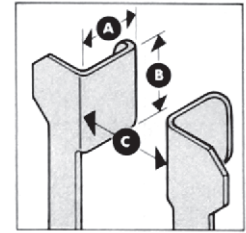

BALFOUR  
**A-SI-4719** = 50 x 75 mm  
**A-SI-4720** = 70 x 85 mm  
**A-SI-4721** = 80 x 80 mm

flexible

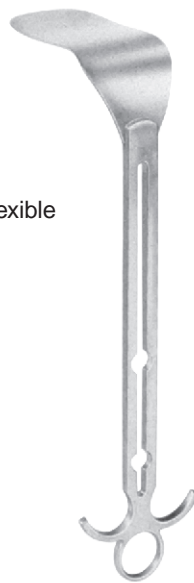

HORGAN  
**A-SI-4722**  
 50 x 125 mm

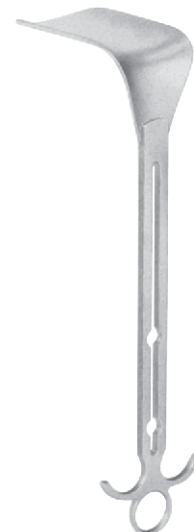

BALFOUR  
**A-SI-4723**  
 70 x 100 mm

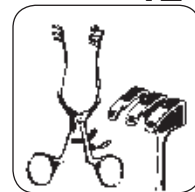

**A-SI-4729**



**A-SI-4724**  
70 x 100 mm



**A-SI-4725**  
45 x 90 mm

O'SULLIVAN-O'CONNOR  
**A-SI-4726** complete,

**A-SI-4727** = 2 Valven, frame with 2 blades

**A-SI-4728** = 1 blade, 70 x 100 mm **12875-03** = 2 blades, valvas, 45 x 90 mm

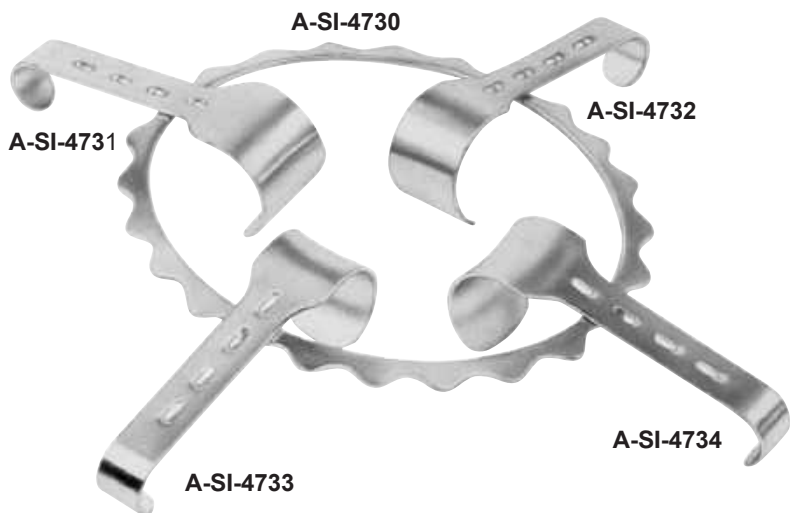

**A-SI-4730**

**A-SI-4732**

**A-SI-4731**

**A-SI-4734**

**A-SI-4733**

DENIS-BROWNE  
**A-SI-4735** complete,

**A-SI-4736**= 1 frame 180 x 150 mm

**A-SI-4737** = 2 , blades 40 x 30 mm

**A-SI-4738** = 2 blades 40 x 40 mm

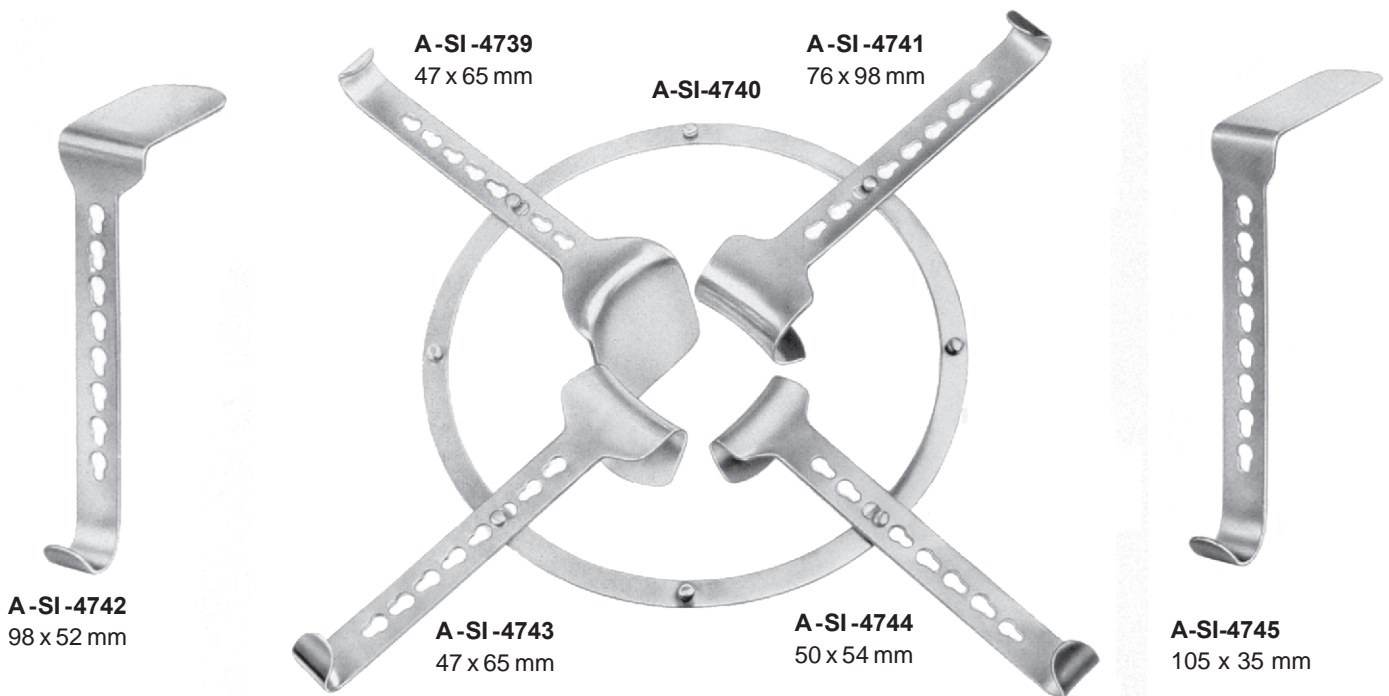

SEMM A-  
**SI-4746** complete consisting of:  
**A-SI-4747** = 1 frame 275 x 250 mm  
**A-SI-4748** = 2 , blades 47 x 65 mm  
**A-SI-4749** = 1 blade, 50 x 54 mm **A-**  
**SI-4750**= 1 blade, 76 x 98 mm **A-SI-**  
**4751** = 1 blade , 98 x 52 mm **A-SI-**  
**4752** = 1 blade, 105 x 35 mm



**ARTIFED**  
INTERNATIONAL



**A-SI-4753**

**A-SI-4754**  
50 x 65 mm

**A-SI-4755**  
40 x 55 mm

**A-SI-4756**  
40 x 55 mm

**A-SI-4757**  
50 x 65 mm

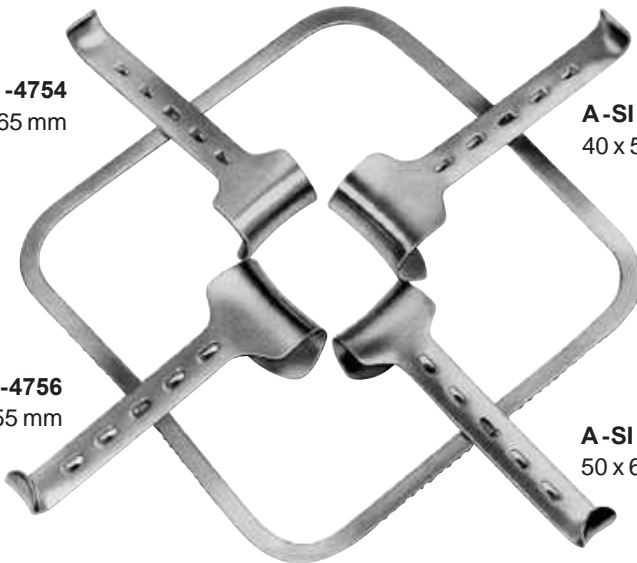

**A-SI-4758**  
260 x 260 mm

**KIRSCHNER**

**A-SI-4759** complete, aus: consisting of,  
**A-SI-4760** = 1 frame rigid, 240 x 240 mm  
**A-SI-4761** = 2 blades, 50 x 65 mm  
**A-SI-4762** = 2 blades, 40 x 55 mm

**KIRSCHNER**

**A-SI-4763** complete consisting of,  
**A-SI-4764** = 1 folding frame, 260 x 260 mm  
**A-SI-4765** = 2 blades 50 x 65 mm  
**A-SI-4766** = 2 blades 40 x 55 mm



**A-SI-4767**  
65 x 80 mm  
2 1/4" x 3 1/4"



**A-SI-4769**  
90 x 65 mm  
3 1/2" x 2 1/2"



Centre blade only

**DOYEN**

**A-SI-4771** = 55 x 95 mm  
**A-SI-4772** = 55 x 105 mm  
**A-SI-4773** = 55 x 115 mm  
**A-SI-4774** = 55 x 120 mm

**A-SI-4768**  
80 x 80 mm  
3 1/4" x 3 1/4"

**A-SI-4770**  
90 x 90 mm  
3 1/2" x 3 1/2"

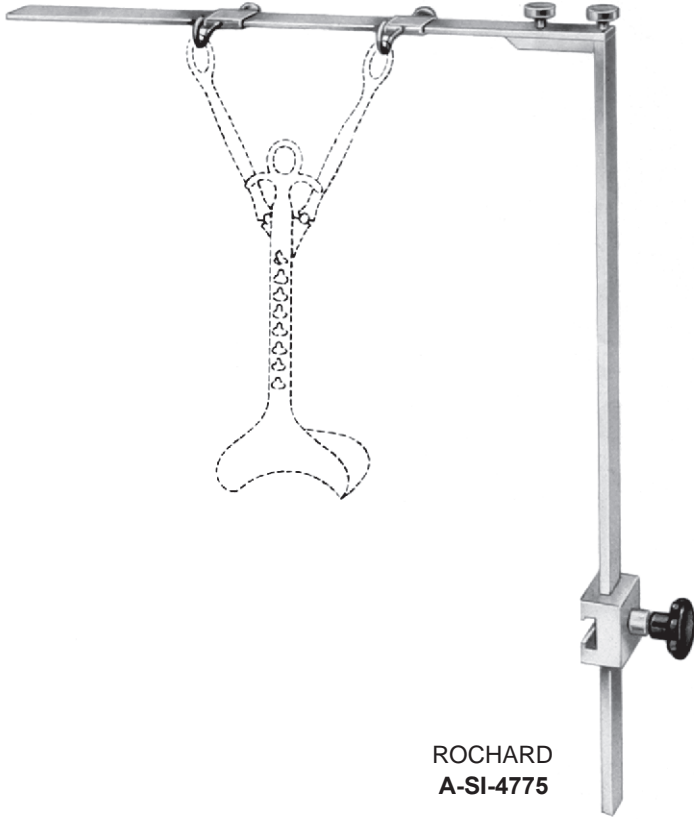

ROCHARD  
A-SI-4775

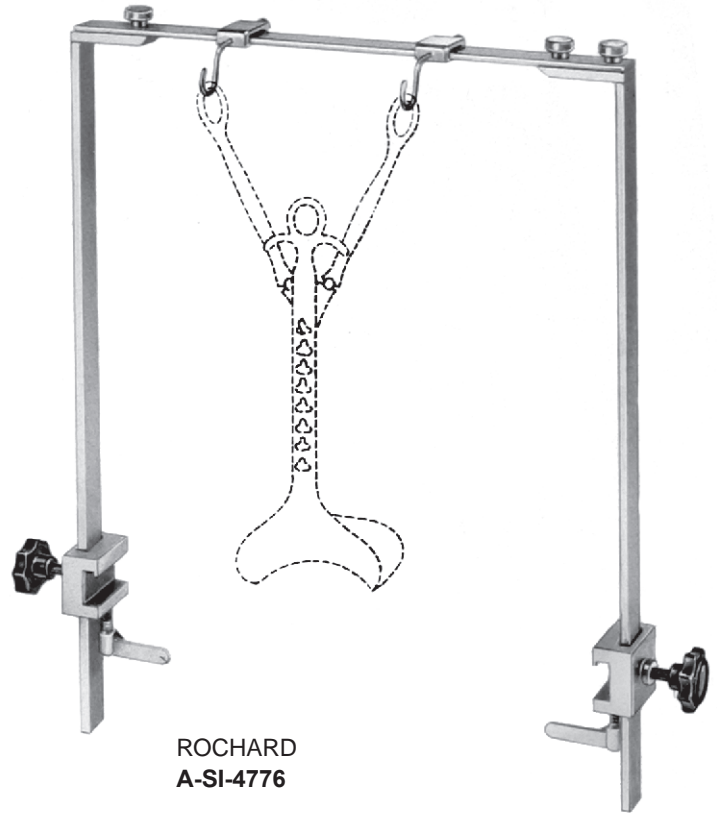

ROCHARD  
A-SI-4776



ROCHARD, 27 cm, 10 1/2"

- A-SI-4777** = 50 x 95 mm, 2" x 3 3/4"
- A-SI-4778** = 50 x 105 mm, 2" x 4 1/8"
- A-SI-4779** = 60 x 120 mm, 2 3/8" x 4 3/4"
- A-SI-4780** = 60 x 135 mm, 2 3/8" x 5 1/4"
- A-SI-47781** = 60 x 155 mm, 2 3/8" x 6 1/8"



ROCHARD  
A-SI-4782  
19 cm / 7 3/4"

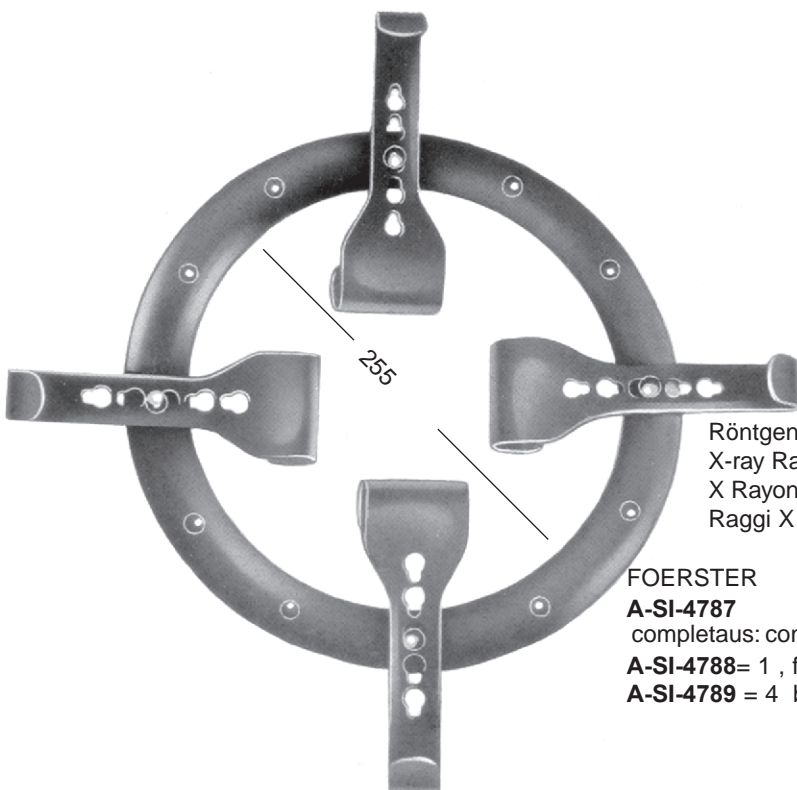

**A-SI-4783**  
52 x 65 mm



**A-SI-4784**  
65 x 80 mm

**A-SI-4785**  
45 x 105  
mm

**A-SI-4786**  
45 x 155 mm

Röntgenfähig  
X-ray Rayos  
X Rayons X  
Raggi X

FOERSTER

**A-SI-4787**

completaus: consisting o

**A-SI-4788** = 1, frame,

**A-SI-4789** = 4 blade 52 x 65 mm

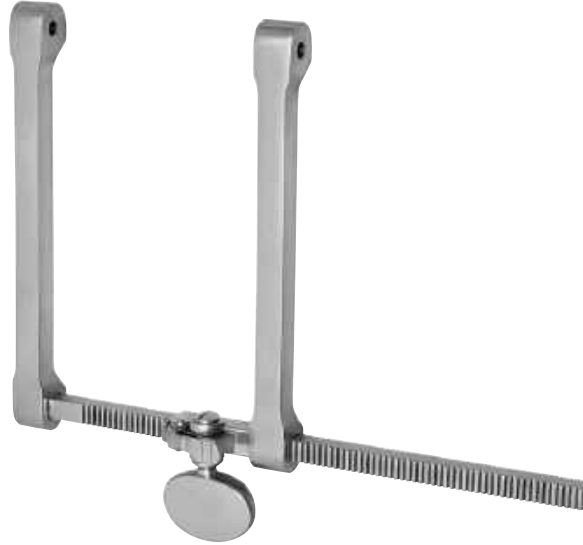

SCOVILLE  
**A-SI-4790**  
spreading 150 mm



SCOVILLE  
**A-SI-4791**  
spreading 150 mm

frame only, with joint



SCOVILLE

**A-SI-4792 A**

**-SI -4793**

Hooks, blunt

50 mm  
70 mm

SCOVILLE

**A-SI-4794 A**

**-SI-4795**

Hooks, sharp

50 mm  
70 mm



SCOVILLE

**A-SI-4796**

60 x 25 mm

**A-SI-4797**

64 x 50 mm

**A-SI-4798**

88 x 25 mm

Blades, toothed



TAYLOR **A-SI-**

**4799 A-SI-**

**4800 A-SI-**

**4801A- SI-480**

**A- SI-4802**

Hooks, sharp

48 x 50 mm  
64 x 50 mm  
64 x 64 mm  
80 x 57 mm



SCOVILLE

**A-SI-4803**

**A-SI-4804**

Hooks, sharp

41 x 38 mm  
67 x 44 mm



TUFFIER

**A-SI-4805** = 200 x 12 mm **A-SI-4806** = 200 x 17 mm **A-SI-4807** = 250 x 25 mm flexible



HABERER

**A-SI-4808** = 20 cm / 8", 17/25 mm **A-SI-4809** = 28 cm / 11", 17/25 mm **A-SI-4810** = 30 cm / 12", 37/45 mm flexible

**A-SI-4811** = 30 mm **A**

**-SI-4812** = 40 mm **A-SI-4813** = 50 mm 33 cm / 13" flexible



REVERDIN

**A-SI-4814**  
28 cm / 11"

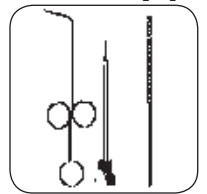

| cm   | in.    | 1 mm Ø           | 1,5 mm Ø         | 2 mm Ø           | 2 mm Ø           |
|------|--------|------------------|------------------|------------------|------------------|
| 10,5 | 4"     |                  |                  | <b>A-SI-4827</b> |                  |
| 11,5 | 4 1/2" | <b>A-SI-4815</b> |                  | <b>A-SI-4828</b> |                  |
| 13,0 | 5"     | <b>A-SI-4816</b> | <b>A-SI-4821</b> | <b>A-SI-4829</b> | <b>A-SI-4836</b> |
| 14,5 | 5 3/4" | <b>A-SI-4817</b> | <b>A-SI-4822</b> | <b>A-SI-4830</b> | <b>A-SI-4837</b> |
| 16,0 | 6 1/4" | <b>A-SI-4818</b> | <b>A-SI-4823</b> | <b>A-SI-4831</b> | <b>A-SI-4838</b> |
| 18,0 | 7"     | <b>A-SI-4819</b> | <b>A-SI-4824</b> | <b>A-SI-4832</b> |                  |
| 20,0 | 8"     | <b>A-SI-4820</b> | <b>A-SI-4825</b> | <b>A-SI-4833</b> |                  |
| 25,0 | 10"    |                  | <b>A-SI-4826</b> | <b>A-SI-4834</b> |                  |
| 30,0 | 12"    |                  |                  | <b>A-SI-4835</b> |                  |

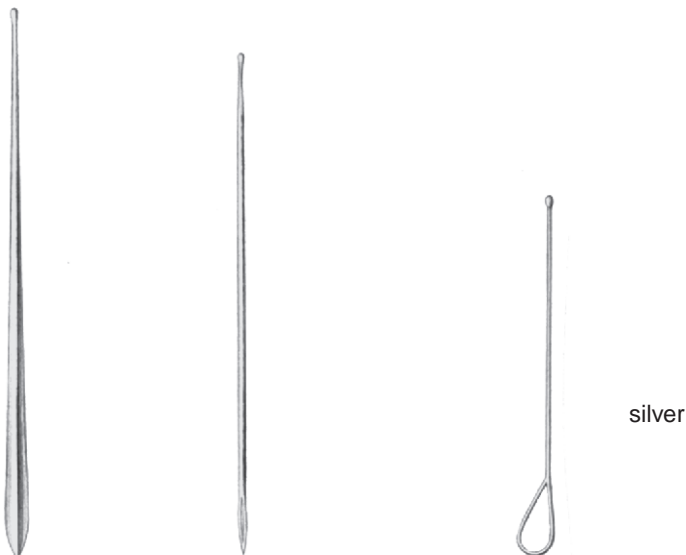

| cm   | in.    | 2 mm Ø           | STACKE           |
|------|--------|------------------|------------------|
| 10,5 | 4"     |                  | <b>A-SI-4839</b> |
| 11,5 | 4 1/2" |                  | <b>A-SI-4840</b> |
| 13,0 | 5"     | <b>A-SI-4842</b> | <b>A-SI-4841</b> |
| 14,5 | 5 3/4" | <b>A-SI-4843</b> |                  |
| 16,0 | 6 1/4" | <b>A-SI-4845</b> | <b>A-SI-4844</b> |